

# NETOPIA™ R7200 SDSL ROUTER

**Nokia Speedlink™ certified**

---

**User's Reference Guide**

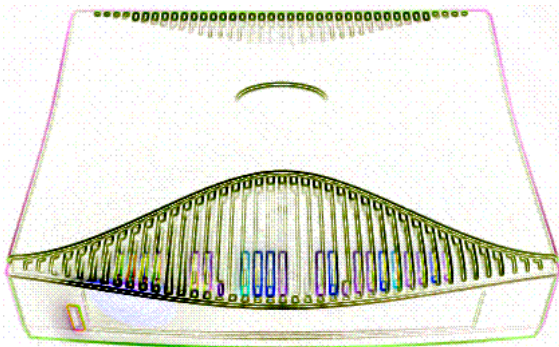

**netopia®**

## **Copyright**

©2000, Netopia, Inc., v.0300  
All rights reserved. Printed in the U.S.A.

This manual and any associated artwork, software, and product designs are copyrighted with all rights reserved. Under the copyright laws such materials may not be copied, in whole or part, without the prior written consent of Netopia, Inc. Under the law, copying includes translation to another language or format.

Netopia, Inc.  
2470 Mariner Square Loop  
Alameda, CA 94501-1010  
U.S.A.

## **Part Number**

For additional copies of this electronic manual, order Netopia part number 6160021-PF-02

## **Printed Copies**

For printed copies of this manual, order Netopia part number TER7200/Doc  
(P/N 6160021-00-02)

# Contents

Welcome to the Netopia R7200 SDSL Router *User's Reference Guide*. This guide is designed to be your single source for information about your Netopia R7200 SDSL Router. It is intended to be viewed on-line, using the powerful features of the Adobe Acrobat Reader. The information display has been designed to present the maximum information in the minimum space on your screen. You can keep this document open while you perform any of the procedures described and find useful information about the procedure you are performing.

This Table of Contents page you are viewing consists of hypertext links to the chapters and headings listed. If you are viewing this on-line, just click any link below to go to that heading.

## Part I: Getting Started

<b>Chapter 1 — Introduction.....</b>	<b>1-1</b>
Overview .....	1-1
Features and capabilities .....	1-1
How to use this guide .....	1-2
<b>Chapter 2 — Setting Up Internet Services .....</b>	<b>2-1</b>
Finding an Internet service provider.....	2-1
Unique requirements .....	2-2
Pricing and support .....	2-2
Endorsements .....	2-2
Deciding on an ISP account .....	2-2
Setting up a Netopia R7200 account.....	2-2
Obtaining an IP address.....	2-2
Obtaining information from the ISP.....	2-3
Local LAN IP address information to obtain .....	2-3
<b>Chapter 3 — Making the Physical Connections.....</b>	<b>3-1</b>
Find a location.....	3-1
What you need .....	3-2
Identify the connectors and attach the cables .....	3-2
Netopia R7200 SDSL Router back panel ports .....	3-3
Netopia R7200 SDSL Router status lights .....	3-4
<b>Chapter 4 — Connecting to Your Local Area Network .....</b>	<b>4-1</b>
Overview .....	4-1
Readying computers on your local network.....	4-1
Connecting to an Ethernet network.....	4-3
10Base-T.....	4-4

Adding an external modem .....	4-5
Connecting to a LocalTalk network .....	4-6
<b>Chapter 5 — Setting up your Router with the SmartStart Wizard</b>	<b>5-1</b>
Before running SmartStart .....	5-2
Setting up your Router with the SmartStart Wizard .....	5-3
SmartStart Wizard configuration screens .....	5-3
Easy option.....	5-4
Advanced option .....	5-5
Sharing the Connection .....	5-6
Configuring TCP/IP on Windows 95, 98, or NT computers .....	5-6
Configuring TCP/IP on Macintosh computers .....	5-10
<b>Chapter 6 — Console-Based Management .....</b>	<b>6-1</b>
Connecting through a Telnet session.....	6-2
Configuring Telnet software .....	6-3
Connecting a console cable to your router .....	6-3
Navigating through the console screens .....	6-4
<b>Chapter 7 — Easy Setup .....</b>	<b>7-1</b>
Easy Setup console screens.....	7-1
Accessing the Easy Setup console screens .....	7-1
Quick Easy Setup connection path .....	7-3
SDSL Line Configuration .....	7-4
Easy Setup Profile .....	7-5
IP Easy Setup .....	7-6
Easy Setup Security Configuration .....	7-7
 <b>Part II: Advanced Configuration</b>	
<b>Chapter 8 — WAN and System Configuration .....</b>	<b>8-1</b>
WAN configuration.....	8-1
Creating a new Connection Profile .....	8-3
The default profile.....	8-6

IP parameters (default profile) screen .....	8-8
IPX parameters (default profile) screen .....	8-9
System configuration screens .....	8-9
Navigating through the system configuration screens.....	8-10
System configuration features .....	8-11
Network protocols setup .....	8-12
Filter sets (firewalls) .....	8-12
IP address serving .....	8-12
Date and time .....	8-12
Console configuration .....	8-13
SNMP (Simple Network Management Protocol) .....	8-14
Security .....	8-14
Upgrade feature set .....	8-14
Logging .....	8-14
Installing the Syslog client .....	8-15
<b>Chapter 9 — Line Backup .....</b>	<b>9-1</b>
WAN Configuration .....	9-2
Backup Configuration screen.....	9-3
IP Setup screen .....	9-4
Connection Profiles .....	9-5
Using Scheduled Connections with Backup .....	9-5
Management/Statistics.....	9-7
QuickView .....	9-9
Event Logs .....	9-9
SNMP Support .....	9-9
<b>Chapter 10 — IP Setup and Network Address Translation .....</b>	<b>10-1</b>
Network Address Translation features .....	10-1
Using Network Address Translation .....	10-3
Associating port numbers with nodes .....	10-6
Advanced IP/IPX router configuration options .....	10-7
Connection Profiles .....	10-8
Network Address Translation guidelines .....	10-10

IP setup .....	10-11
IP subnets .....	10-15
Static routes .....	10-17
IP address serving .....	10-21
IP Address Pools .....	10-24
DHCP NetBIOS Options .....	10-26
MacIP (KIP forwarding) setup .....	10-28
<b>Chapter 11 — IPX Setup .....</b>	<b>11-1</b>
IPX features .....	11-1
IPX definitions .....	11-1
Internetwork Packet Exchange (IPX) .....	11-1
IPX address .....	11-2
Socket .....	11-2
Routing Information Protocol (RIP) .....	11-2
Service Advertising Protocol (SAP) .....	11-2
NetBIOS .....	11-3
IPX spoofing .....	11-3
IPX setup screen .....	11-3
IPX routing tables .....	11-5
<b>Chapter 12 — AppleTalk Setup .....</b>	<b>12-1</b>
AppleTalk networks .....	12-1
AppleTalk protocol .....	12-1
MacIP .....	12-3
AURP .....	12-3
Routers and seeding .....	12-3
Installing AppleTalk .....	12-4
Configuring AppleTalk .....	12-6
EtherTalk setup .....	12-6
LocalTalk setup .....	12-7
AURP setup .....	12-8

<b>Chapter 13 — Monitoring Tools .....</b>	<b>13-1</b>
Quick View status overview .....	13-1
General status .....	13-2
Current status .....	13-3
Status lights .....	13-3
Statistics & Logs .....	13-4
General Statistics .....	13-4
Event histories .....	13-5
Routing tables .....	13-7
Served IP Addresses.....	13-10
System Information.....	13-12
SNMP .....	13-12
The SNMP Setup screen.....	13-13
SNMP traps .....	13-14
Web-based management pages .....	13-16
System Information page.....	13-16
Event History pages .....	13-17
<b>Chapter 14 — Security .....</b>	<b>14-1</b>
Suggested security measures.....	14-1
User accounts .....	14-1
Dial-in console access.....	14-3
Enable SmartStart/SmartView/Web server .....	14-4
Telnet access .....	14-4
About filters and filter sets .....	14-4
What's a filter and what's a filter set?.....	14-4
How filter sets work.....	14-5
How individual filters work.....	14-6
Design guidelines.....	14-11
Working with IP filters and filter sets.....	14-12
Adding a filter set.....	14-13
Viewing filter sets.....	14-16
Modifying filter sets .....	14-17

Deleting a filter set.....	14-17
A sample IP filter set .....	14-17
IPX filters .....	14-21
IPX packet filters .....	14-22
IPX packet filter sets .....	14-23
IPX SAP filters .....	14-25
IPX SAP filter sets .....	14-27
Firewall tutorial .....	14-29
General firewall terms .....	14-29
Basic IP packet components .....	14-29
Basic protocol types .....	14-29
Firewall design rules.....	14-30
Filter basics .....	14-33
Example filters .....	14-34
<b>Chapter 15 — Utilities and Diagnostics .....</b>	<b>15-1</b>
Ping .....	15-2
Trace Route .....	15-4
Telnet client.....	15-5
Disconnect Telnet console session .....	15-6
Factory defaults.....	15-6
Transferring configuration and firmware files with TFTP....	15-7
Updating firmware .....	15-7
Downloading configuration files .....	15-8
Uploading configuration files .....	15-9
Transferring configuration and firmware files with XMODEM.....	15-9
Updating firmware .....	15-10
Downloading configuration files .....	15-11
Uploading configuration files .....	15-11
Restarting the system.....	15-12



## Part III: Appendixes

<b>Appendix A — Troubleshooting</b> .....	<b>A-1</b>
Configuration problems .....	A-1
Console connection problems .....	A-2
Network problems .....	A-2
How to reset the router to factory defaults .....	A-3
Power outages.....	A-3
Technical support .....	A-4
How to reach us.....	A-4
<b>Appendix B — Understanding IP Addressing</b> .....	<b>B-1</b>
What is IP?.....	B-1
About IP addressing.....	B-1
Subnets and subnet masks .....	B-2
Example: Using subnets on a Class C IP internet....	B-3
Example: Working with a Class C subnet.....	B-5
Distributing IP addresses .....	B-5
Technical note on subnet masking.....	B-6
Configuration .....	B-7
Manually distributing IP addresses .....	B-8
Using address serving.....	B-8
Tips and rules for distributing IP addresses.....	B-9
Nested IP subnets .....	B-11
Broadcasts.....	B-13
Packet header types.....	B-13
<b>Appendix C — Understanding Netopia NAT Behavior</b> .....	<b>C-1</b>
Network configuration.....	C-1
Background .....	C-1
Exported services .....	C-5
Important notes.....	C-6
Configuration.....	C-7
Summary .....	C-8

<b>Appendix D — Binary Conversion Table.....</b>	<b>D-1</b>
<b>Appendix E — Further Reading.....</b>	<b>E-1</b>
<b>Appendix F — Technical Specifications and Safety Information... F-1</b>	<b>F-1</b>
Pinouts for Auxiliary port modem cable.....	F-1
Description.....	F-2
Power requirements .....	F-2
Environment .....	F-2
Software and protocols.....	F-3
Agency approvals.....	F-4
Regulatory notices .....	F-4
Important safety instructions .....	F-5
<b>Appendix G — About SDSL.....</b>	<b>G-1</b>
<b>Glossary.....</b>	<b>GL-1</b>
<b>Index .....</b>	<b>Index-1</b>
<b>Limited Warranty and Limitation of Remedies .....</b>	<b>1</b>

# ***Part I: Getting Started***



# Chapter 1

## Introduction

---

### Overview

The Netopia R7200 SDSL Router is a full-featured, stand-alone, multiprotocol router for connecting diverse local area networks (LANs) to the Internet and other remote networks. Once your Netopia R7200 SDSL Router is connected to your computer, and your account is activated by your network service provider, you will have a fast Symmetric Digital Subscriber Line (SDSL) connection between your PC or LAN and the telephone company's network of high-speed digital facilities.

This section covers the following topics:

- [“Features and capabilities” on page 1-1](#)
- [“How to use this guide” on page 1-2](#)

---

### Features and capabilities

The Netopia R7200 SDSL Router provides the following features:

- Certified for use with the Speedlink™ access concentrator from Nokia
- Support for IP and IPX routing for Internet and intranet connectivity
- IP address serving (over Ethernet or a WAN link) that allows local or remote network nodes to acquire an IP address automatically and dynamically from a designated pool of available addresses
- Multi-speed symmetrical transmission from 192 Kbps up to 1.5 Mbps to provide scalability without additional equipment investment
- All digital, continuous-availability networking, eliminating dialing and providing lower, more predictable transmission costs
- Connectivity to Ethernet LANs via a built-in 8-port 10Base-T hub with uplink port
- Status lights (LEDs) for easy monitoring and troubleshooting
- Support for console-based management over Telnet or serial cable connection
- Support for remote configuration by your reseller, your network administrator, or technicians at Netopia, Inc., via external modem or via IP network
- Wall-mountable, bookshelf (side-stackable), or desktop-stackable design for efficient space usage
- SmartIP™, making it simple and economical to connect a workgroup of users to the Internet or a remote IP network by using Network Address Translation and a single IP address
- AppleTalk support (available as a separate add-on AppleTalk kit, including a firmware feature set enhancement and custom HD-15 dual RJ-11 PhoneNET® connector), allowing for LocalTalk-to-Ethernet routing, assigning IP addresses to Macintosh users (MacIP), IP functionality for LocalTalk users, and AURP

tunneling for connectivity between remote AppleTalk networks

- Web-based management pages aid in managing your router. Internet browsers such as Netscape Navigator and Microsoft's Internet Explorer can be used for the web-based management pages.

---

### *How to use this guide*

This guide is designed to be your single source for information about your Netopia R7200 SDSL Router. It is intended to be viewed on-line, using the powerful features of the Adobe Acrobat Reader. The information display has been deliberately designed to present the maximum information in the minimum space on your screen. You can keep this document open while you perform any of the procedures described and find useful information about the procedure you are performing.

If you prefer to work from hard copy rather than on-line documentation, you can also print out all of the manual, or individual sections. The pages are formatted to print on standard 8 1/2 by 11 inch paper. We recommend that you print on three-hole punched paper, so you can put the pages in a binder for future reference. For your convenience, a printed copy can be purchased from Netopia. Order part number TER7200/Doc.

This guide is organized into chapters describing the Netopia R7200's advanced features. You may want to read each chapter's introductory section to familiarize yourself with the various features available.

Use the guide's table of contents and index to locate informational topics.

## Chapter 2

# Setting Up Internet Services

This chapter describes how to obtain and set up Internet services.

This section covers the following topics:

- “Finding an Internet service provider” on page 2-1
- “Deciding on an ISP account” on page 2-2
- “Obtaining information from the ISP” on page 2-3

**Note:** Some companies act as their own ISP. For example, some organizations have branch offices that can use the Netopia R7200 to access the Internet via the main office in a point-to-point scenario. If you install the Netopia R7200 in this type of environment, refer to the following sections for specific information you must receive from the network administrator to configure the Netopia R7200 properly.

---

### *Finding an Internet service provider*

The Netopia R7200 SDSL Router provides its high speed symmetric (two-way) digital connection to the Internet through a Competitive Local Exchange Carrier (CLEC) -- a type of mini phone company. The CLEC uses a compatible type of switching equipment known as a Digital Subscriber Line Access Multiplexer (DSLAM). The DSLAM that you connect to with your Netopia Router must be capable of handling these symmetric connections. The Netopia R7200 is certified for use with the Nokia Speedlink™ DSLAM.

If you have purchased your Netopia Router through a Netopia ISP partner, you can be sure that an account that supports SDSL connections will be available.

If your area has more than one ISP, the following considerations will help you decide which ISP is best suited for your requirements.

In determining which Internet service provider (ISP) to establish your account with, make sure that your ISP supports connections via a CLEC with a compatible DSLAM, the Nokia's Speedlink™ central office equipment.

Use an ISP that provides Internet access through a Symmetric Digital Subscriber Line (SDSL) and that supports the Netopia R7200 SDSL Router. If you would like to use an ISP that you already have a relationship with but that is not familiar with the Netopia R7200, call us at 1-800-NETOPIA. Our representative can call your ISP and introduce them to the product. If necessary, we will provide them with the technical background they need to support the product.

### *Unique requirements*

Make sure the ISP can meet any unique requirements you may have, such as:

- Dynamic or static IP addressing
- Class C IP address
- Custom domain name
- Multiple e-mail addresses
- Web site hosting

### *Pricing and support*

Compare pricing, service, and technical support service among various ISPs.

### *Endorsements*

Consider recommendations from colleagues and reviews in publications. Netopia lists Netopia Certified ISPs on our Web site at <http://www.netopia.com>.

---

### *Deciding on an ISP account*

Your ISP may offer various Internet access account plans. Typically, these plans vary by usage charges and the number of host IP addresses supplied. Evaluate your networking needs and discuss them with your ISP before deciding on a plan for your network.

### *Setting up a Netopia R7200 account*

Check whether your ISP has the Netopia R7200 on its list of supported products that have been tested with a particular configuration. If the ISP does not have the Netopia R7200 on such a list, describe the Netopia R7200 in as much detail as needed, so your ISP account can be optimized. As appropriate, refer your ISP to Netopia's Web site [www.netopia.com](http://www.netopia.com) for more information.

### *Obtaining an IP address*

Typically, each network computer that requires Internet access requires its own unique IP address. If some or all network computers require simultaneous Internet access, obtain a block of IP host addresses large enough for each computer to have its own address, plus one for the Netopia R7200.

Consider expected growth in your network when deciding on the number of addresses to obtain. Alternatively, you can use the Network Address Translation feature of SmartIP.

#### *SmartIP*

The Netopia R7200 SDSL Router supports the SmartIP™ feature, which includes Network Address Translation.

Network Address Translation provides Internet access to the network connected to the Netopia R7200 using only a single IP address. These routers translate between the internal or local area network (LAN) addresses and a single external IP address, and route accordingly.



For more information on Network Address Translation, see [Chapter 10, "IP Setup and Network Address Translation."](#)

---

## *Obtaining information from the ISP*

After your account is set up, the ISP should send you the IP parameter information that will help you configure the Netopia R7200.

### *Local LAN IP address information to obtain*

Your ISP will need to provide you with the following information:

- The default gateway IP address (same as remote IP address in most cases)
- Local WAN IP address and subnet mask
- Primary and secondary domain name server (DNS) IP addresses
- Domain name (usually the same as the ISP's domain name unless you have registered for your own individual domain name)

**Note:** The default gateway, WAN address and mask, DNS, and domain name are all obtainable via WAN DHCP, if your ISP supports it.

### *With Network Address Translation*

If you are using SmartIP (NAT), you should obtain the following:

- If you are connecting to a remote site using Network Address Translation on your router, your provider will not define the IP address information on your local LAN. You can define this information based on an IP configuration that may already be in place for the existing network. Alternatively, you can use the default IP address range used by the router.

### *Without Network Address Translation*

If you are not using Network Address Translation, you will need to obtain all of the local LAN IP address information from your ISP.

If you are not using SmartIP (NAT), you should obtain:

- The number of Ethernet IP host addresses available with your account and the first usable IP host address in the address block
- The Ethernet IP address for your Netopia R7200
- The Ethernet IP subnet mask address for your Netopia R7200



## Chapter 3

# Making the Physical Connections

This section tells you how to make the physical connections to your Netopia R7200 SDSL Router. This section covers the following topics:

- “Find a location” on page 3-1
- “What you need” on page 3-2
- “Identify the connectors and attach the cables” on page 3-2
- “Netopia R7200 SDSL Router back panel ports” on page 3-3
- “Netopia R7200 SDSL Router status lights” on page 3-4

---

### Find a location

When choosing a location for the Netopia Router, consider:

- Available space and ease of installation
- Physical layout of the building and how to best use the physical space available for connecting your Netopia Router to the LAN
- Available wiring and jacks
- Distance from the point of installation to the next device (length of cable or wall wiring)
- Ease of access to the front of the unit for configuration and monitoring
- Ease of access to the back of the unit for checking and changing cables
- Cable length and network size limitations when expanding networks

For small networks, install the Netopia R7200 near one of the LANs. For large networks, you can install the Netopia R7200 in a wiring closet or a central network administration site.

---

## What you need

Locate all items that you need for the installation.

Included in your router package are:

- The Netopia R7200 SDSL Router
- A power adapter and cord with a mini-DIN8 connector
- One RJ-45 Ethernet cable
- One RJ-11 Telco (or Line) cable
- A dual DE-9 and mini-DIN8 to DE-9 console cable (for a PC or a Macintosh)
- The Netopia CD containing an Internet browser, Adobe Acrobat Reader for Windows and Macintosh, ZTerm terminal emulator software and NCSA Telnet for Macintosh, and documentation

You will need:

- A Windows 95 or 98-based PC or a Macintosh computer with Ethernet connectivity for configuring the Netopia R7200. This may be built-in Ethernet or an add-on card, with TCP/IP installed and configured. See ["Before running SmartStart" on page 5-2](#).
- An SDSL wall outlet wired for a connection to a Competitive Local Exchange Carrier (CLEC) who supports Symmetric Digital Subscriber Line connections.

---

## Identify the connectors and attach the cables

Identify the connectors and switches on the back panel and attach the necessary Netopia Router cables.

The figure below displays the back of the Netopia R7200 SDSL Router.

*Netopia R7200 with SDSL back panel*

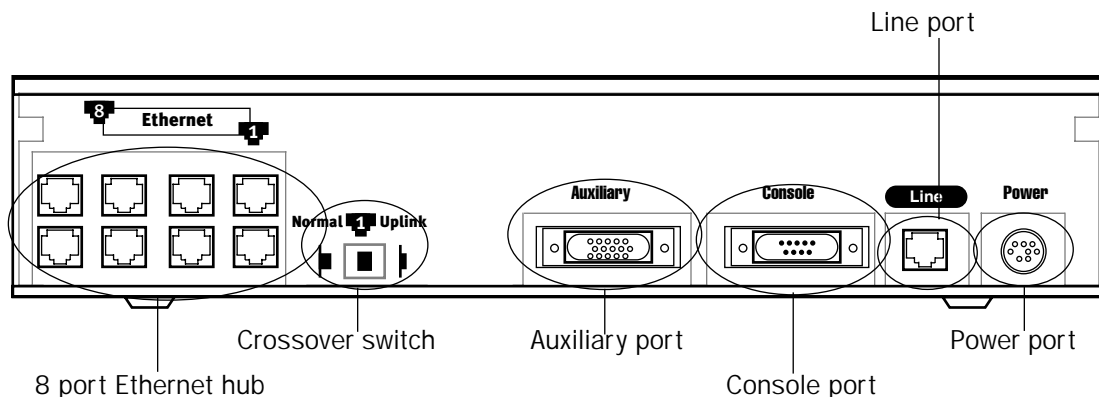

1. Connect the mini-DIN8 connector from the power adapter to the power port, and plug the other end into an electrical outlet.
2. Connect one end of the RJ-11 cable to the Line port, and the other end to your SDSL wall outlet.

3. Connect the Ethernet cable to any of the Ethernet ports on the router.

(If you are connecting the router to an existing Ethernet hub, use Ethernet port #1 on the router and set the crossover switch to the **Uplink** position.)

You should now have: the power adapter plugged in; the Ethernet cable connected between the router and your computer; and the SDSL cable connected between the router and the SDSL wall outlet.

---

### *Netopia R7200 SDSL Router back panel ports*

The following table describes all the Netopia R7200 SDSL Router back panel ports.

Port	Description
Power port	A mini-DIN8 power adapter cable connection.
Line port	An RJ-11 telephone-style jack labeled Line for your SDSL connection.
Console port	A DE-9 console port for a direct serial connection to the console screens. You can use this if you are an experienced user. See <a href="#">“Connecting a console cable to your router” on page 6-3.</a>
Auxiliary port	An HD-15 auxiliary port for attaching an external modem or the optional AppleTalk kit.
Crossover switch	A crossover switch with Normal and Uplink positions. If you use Ethernet Port #1 for a direct Ethernet connection between a computer and the router, set the switch to the <b>Normal</b> position. If you are connecting the router to an Ethernet hub, use Ethernet port #1 on the router and set the switch to the <b>Uplink</b> position.
8-port Ethernet hub	Eight Ethernet jacks. You will use one of these to configure the Netopia R7200. For a new installation, use the Ethernet connection. Alternatively, you can use the console connection to run console-based management using a direct serial connection. You can either connect your computer directly to any of the Ethernet ports on the router, or connect both your computer and the router to an existing Ethernet hub on your LAN.

## Netopia R7200 SDSL Router status lights

The figure below represents the Netopia R7200 status light (LED) panel.

Netopia R7200 LED front panel

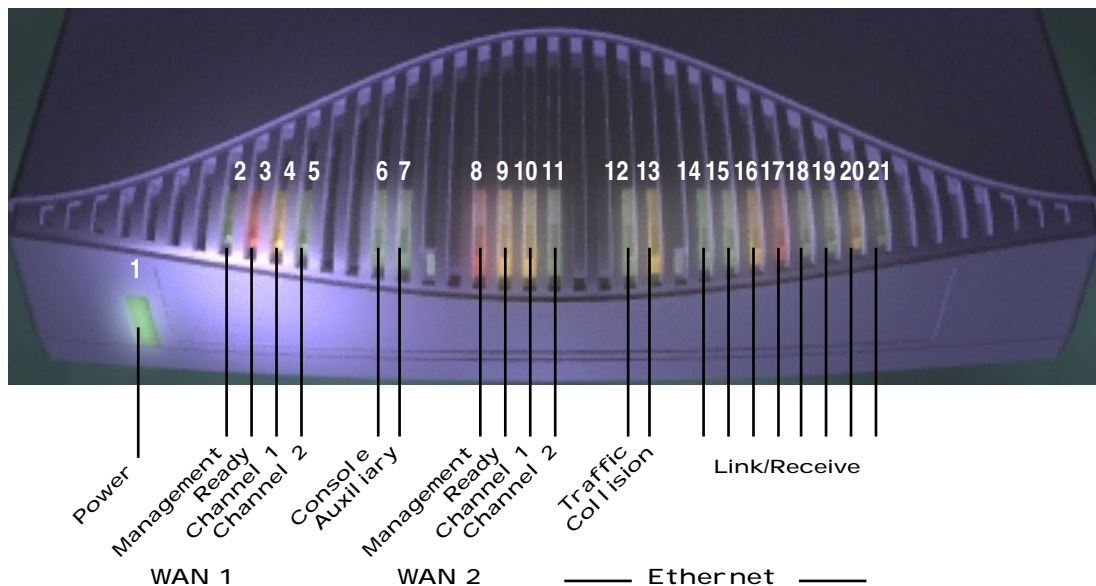

The following table summarizes the meaning of the various LED states and colors:

When this happens...	the LEDs...
The WAN interface is operational	3 is <b>green</b> .
The line is unavailable	3 flashes <b>red</b> .
The WAN has carrier	4 is <b>green</b> .
Data is transmitted or received on the WAN	4 flashes <b>yellow</b> .
Carrier is asserted	6 and 7 are <b>green</b> .
Data is transmitted or received	6 and 7 flash <b>yellow</b> .
Data is transmitted or received by the ethernet controller	12 flashes <b>yellow</b> .
The Ethernet interface detects a collision	13 flashes <b>red</b> .
Link is detected	14 though 21 are <b>solid green</b> .
Data are received on their respective ports	14 though 21 <b>flash green</b> .
<b>Note:</b> 5 and 8 through 11 are unused, since the SDSL link is carried only on WAN channel 1. Also, Console carrier (6) is ignored if the console is not configured for a remote modem.	

## Chapter 4

# Connecting to Your Local Area Network

This chapter describes how to physically connect the Netopia R7200 to your local area network (LAN). Before you proceed, make sure the Netopia R7200 is properly configured. You can customize the router's configuration for your particular LAN requirements using console-based management (see ["Console-Based Management" on page 6-1](#)).

This section covers the following topics:

- ["Overview" on page 4-1](#)
- ["Readying computers on your local network" on page 4-1](#)
- ["Connecting to an Ethernet network" on page 4-3](#)
- ["Adding an external modem" on page 4-5](#)
- ["Connecting to a LocalTalk network" on page 4-6](#)

---

### Overview

You can connect the Netopia R7200 to an IP or IPX network that uses Ethernet.

If you have purchased the AppleTalk feature expansion kit, you can also connect the router to a LocalTalk network that uses PhoneNET cabling.

Additionally, you can connect an external modem. See ["Adding an external modem" on page 4-5](#).

#### **Caution!**

Before connecting the Netopia R7200 to any AppleTalk LANs that contain other AppleTalk routers, you should read ["Routers and seeding" on page 12-3](#).

See the later sections in this chapter for details on how to connect the Netopia R7200 to different types of networks.

---

### Readying computers on your local network

PC and Macintosh computers must have certain components installed before they can communicate through the Netopia R7200. The following illustration shows the minimal requirements for a typical PC or Macintosh computer.

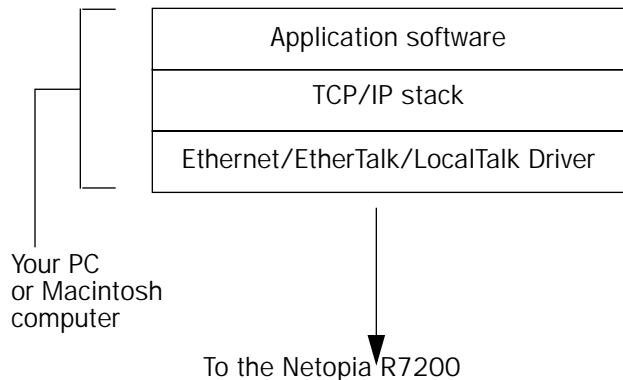

**Application software:** This is the software you use to send e-mail, browse the World Wide Web, read newsgroups, etc. These applications may require some configuration. Examples include the Eudora e-mail client and the Web browsers Microsoft Internet Explorer and Netscape Navigator.

**TCP/IP stack:** This is the software that lets your PC or Macintosh computer communicate using Internet protocols. TCP/IP stacks must be configured with some of the same information you used to configure the Netopia R7200. There are a number of TCP/IP stacks available for PC computers. Windows 95 includes a built-in TCP/IP stack. See ["Configuring TCP/IP on Windows 95, 98, or NT computers"](#) on page 5-6. Macintosh computers use either MacTCP or Open Transport. See ["Configuring TCP/IP on Macintosh computers"](#) on page 5-10.

**Ethernet:** Ethernet hardware and software drivers enable your PC or Macintosh computer to communicate on the LAN.

**EtherTalk and LocalTalk:** These are AppleTalk protocols used over Ethernet.

Once the Netopia R7200 is properly configured and connected to your LAN, PC and Macintosh computers that have their required components in place will be able to connect to the Internet or other remote IP networks.



---

## Connecting to an Ethernet network

The Netopia R7200 supports Ethernet connections through its eight Ethernet ports. The router automatically detects which Ethernet port is in use.

You can connect either 10Base-T or EtherWave Ethernet networks to the Netopia R7200.

The following table displays some important attributes of these types of Ethernet.

Attribute	EtherWave	10Base-T
Max. length of backbone, branch, or end to end (cable length)	330 feet (100 meters)	330 feet (100 meters)
Cable type	Twisted pair (10Base-T)	Twisted pair (10Base-T)
Netopia R7200 port used	Ethernet	Ethernet
Other restrictions	Maximum 8 devices (daisy chained)	No daisy chain

## 10Base-T

You can connect a standard 10Base-T Ethernet network to the Netopia R7200 using any of its available Ethernet ports.

*Netopia R7200 back panel*

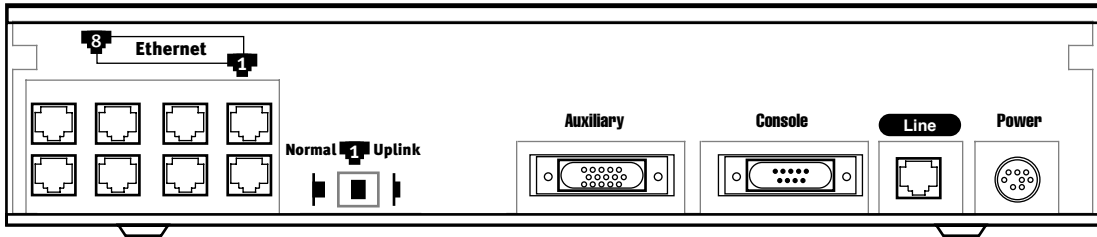

*The Netopia R7200 in a 10Base-T network*

To connect your 10Base-T network to the Netopia R7200 through an Ethernet port, use a 10Base-T cable with RJ-45 connectors.

If you have more than eight devices to connect, you can attach additional devices using another 10Base-T hub.

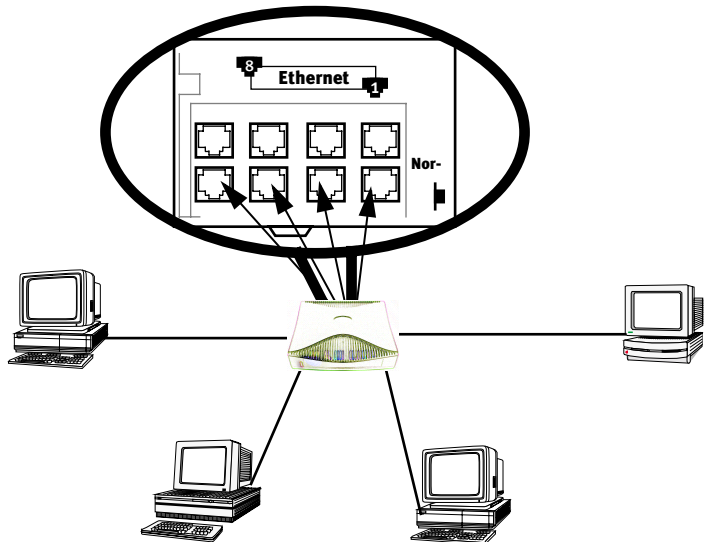

If you add devices connected through a hub, connect the hub to Ethernet port number 1 on the Netopia R7200 SDSL Router and set the Normal/Uplink crossover switch to Uplink.

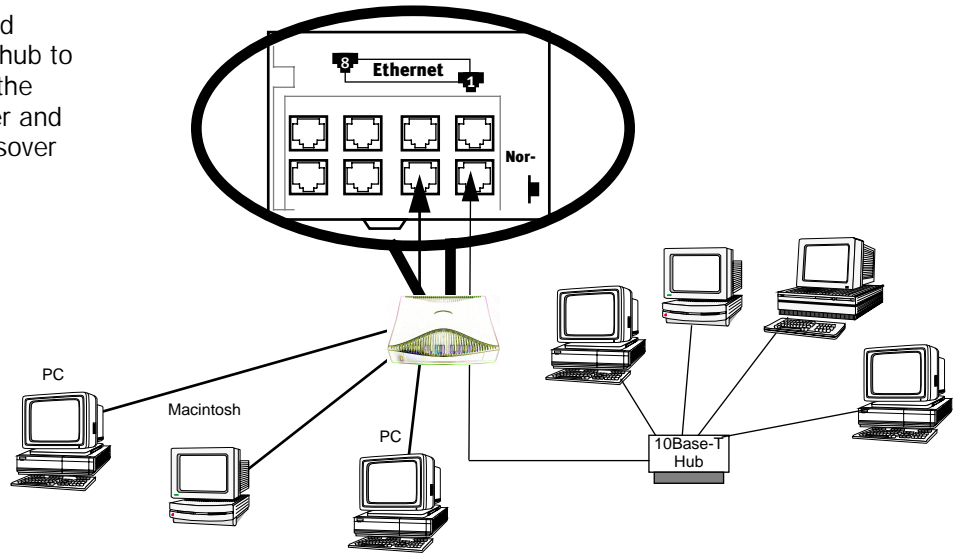

## Adding an external modem

You may want to add an external modem to your Auxiliary port. Obtain the special DB-25 external modem cable (TE6/DB25) either from your reseller or directly from Netopia.

*Netopia R7200 Auxiliary port for connecting an external modem*

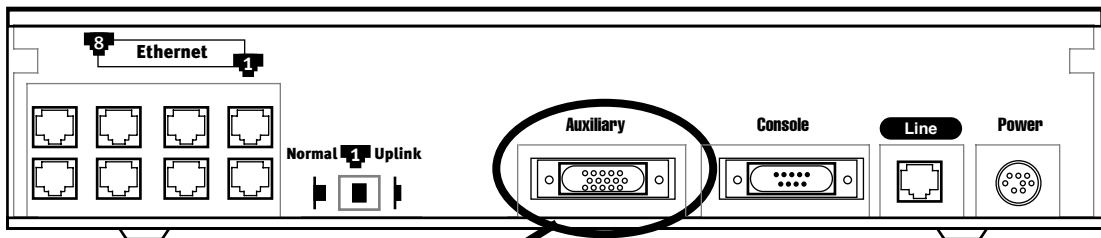

Auxiliary connection port  
HD-15 (female)

By default, the Auxiliary port on your Netopia R7200 is enabled for remote console configuration via an external asynchronous modem. This means that all you have to do is connect your modem to the Auxiliary port and configure its settings in the **Line Configuration** screens under the **WAN Configuration** menu.

For pinout information on the HD-15 to DB-25 modem cable, see ["Pinouts for Auxiliary port modem cable,"](#) in Appendix F, "Technical Specifications and Safety Information."

## Connecting to a LocalTalk network

If you have purchased the AppleTalk feature expansion kit, you can also connect the router to an AppleTalk network that uses either Ethernet or LocalTalk. Refer to the sheet of optional feature set add-ons in your Netopia R7200 documentation folio.

The AppleTalk feature expansion kit includes a dual RJ-11 PhoneNET connector that attaches to the Auxiliary port on the Netopia R7200.

*Netopia R7200 Auxiliary port for connecting to LocalTalk*

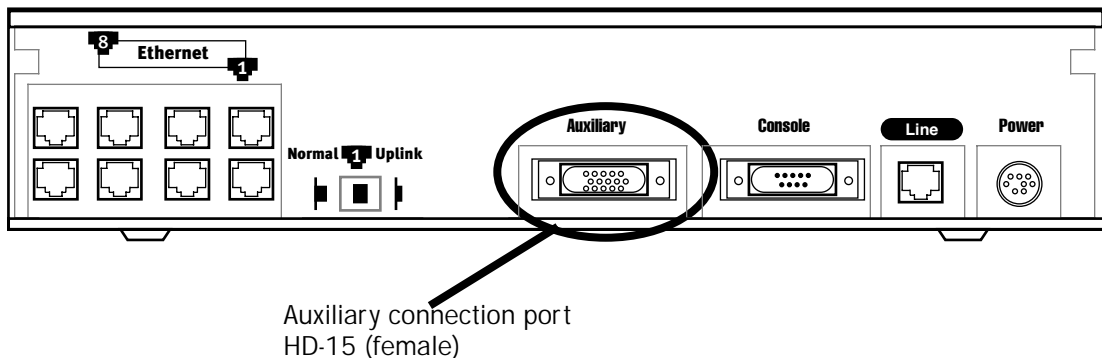

Connect the male HD-15 end of the LocalTalk cable to the **Auxiliary** port on your Netopia R7200. Connect the other end of the cable to your LocalTalk network. You can use only one connection on the Auxiliary port. You cannot use both the PhoneNET connector and an external modem.

If your LocalTalk network is not based on standard PhoneNET cabling, use a PhoneNET-to-LocalTalk adaptor cable available from Farallon division of Netopia. Connect the adaptor cable's RJ-11 connector to the AppleTalk cable's PhoneNET connector. Connect the cable's mini-DIN-3 connector to your LocalTalk network.

Be sure to observe the standard rules governing maximum cable lengths and limits on the number of nodes on a PhoneNET network. The dual RJ-11 PhoneNET connector allows insertion in the LocalTalk daisy chain or at the end. If the device is connected at the end of the daisy chain, you must install the accompanying terminator.

For detailed configuration instructions see ["AppleTalk Setup"](#) on page 12-1.

## Chapter 5

# Setting up your Router with the SmartStart Wizard

Once you've connected your router to your computer and your telecommunications line and installed a web browser, you're ready to run the Netopia SmartStart™ Wizard. The SmartStart Wizard will help you set up the router and share the connection. The SmartStart Wizard walks you through a series of questions and, based on your responses, automatically configures the router for connecting your LAN to the Internet or to your remote corporate network.

The SmartStart Wizard will:

- automatically check your Windows 95, 98, or NT PC's TCP/IP configuration to be sure you can accept a dynamically assigned IP address, and change it for you if it is not set for dynamic addressing
- check the physical connection from your computer to your router without your having to enter an IP address
- assign an IP address to your router

This chapter covers the following topics:

- ["Before running SmartStart" on page 2](#)
- ["Setting up your Router with the SmartStart Wizard" on page 3](#)
- ["Sharing the Connection" on page 6](#)

## Before running SmartStart

Be sure you have connected the cables and power source as described in Step 1 "Connect the Router" guide contained in your Netopia folio.

Before you launch the SmartStart application, make sure your computer meets the following requirements:

	PC	Macintosh
System software	Windows 95, 98, or NT operating system	MacOS 7.5 or later
Connectivity software	TCP/IP must be installed and properly configured. See <a href="#">"Configuring TCP/IP on Windows 95, 98, or NT computers" on page 5-6</a>	MacTCP or Open Transport TCP/IP must be installed and properly configured. See <a href="#">"Configuring TCP/IP on Macintosh computers" on page 5-10</a> .
Connectivity hardware	Ethernet card (10Base-T)	Either a built-in or third-party Ethernet card (10Base-T)
Browser software	Netscape Communicator™ or Microsoft Internet Explorer, included on the Netopia CD. Required for web-based registration and web-based monitoring.	

### Notes:

- The computer running SmartStart must be on the same Ethernet cable segment as the Netopia R7200. Repeaters, such as 10Base-T hubs between your computer and the Netopia R7200, are acceptable, but devices such as switches or other routers are not.
- SmartStart for the PC will set your TCP/IP control panel to "Obtain an IP address automatically" if it is not already set this way. This will cause your computer to reboot. If you have a specified IP address configured in the computer, you should make a note of it before running SmartStart, in case you do not want to use the dynamic addressing features built in to the Netopia Router and need to restore the fixed IP address.

## Setting up your Router with the SmartStart Wizard

The SmartStart Wizard is tailored for your platform, but it works the same way on either a PC or a Macintosh. Insert the Netopia CD, and in the desktop navigation screen that appears, launch the SmartStart Wizard application.

### SmartStart Wizard configuration screens

The screens described in this section are the default screens shipped on the Netopia CD. They derive from two initialization (.ini) files included in the same directory as the SmartStart application file. Your reseller or your ISP may have supplied you with customized versions of these files.

- If you have received a CD or diskette that has been customized by your reseller or ISP, you can run the SmartStart Wizard directly from the CD or diskette and follow the instructions your reseller or ISP provides. This makes your Netopia R7200 configuration even easier.
- If you have received only the .ini files from your reseller or ISP, perform the following:
  - Copy the entire directory folder containing the SmartStart Wizard application from the Netopia CD to your hard disk.
  - Copy the customized .ini files to the same directory folder that contains the SmartStart Wizard application, allowing the copy process to overwrite the original .ini files.
  - Run the SmartStart Wizard from your hard disk. You can then follow the instructions your reseller or ISP provides.

The SmartStart Wizard presents a series of screens to guide you through the preliminary configuration of a Netopia R7200. It will then create a connection profile using the information you supply to it.

**Welcome screen.** The first screen welcomes you to the SmartStart Wizard configuration utility.

Click the Next button after you have responded to the interactive prompts in each screen.

The Help button will display useful information to assist you in responding to the interactive prompts.

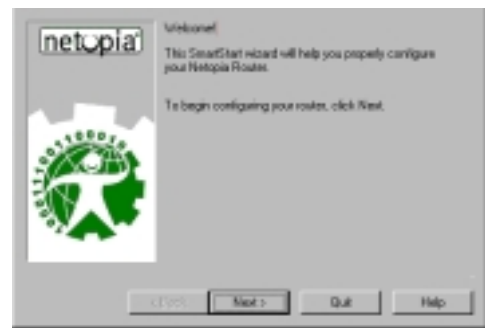

**Setup Options screen.** You can choose either Easy or Advanced setup.

- If you choose Easy, SmartStart automatically uses the preconfigured IP addressing setup built into your router. This is the best choice if you are creating a new network or don't already have an IP addressing scheme on your new network.

If you choose Easy, you will see a "Connection Test screen," like the one shown below while SmartStart checks the connection to your router.

- If you choose Advanced, skip to [page 5-5](#) now. The SmartStart Wizard displays the "Router IP Address screen" on [page 5-5](#), in which you can choose ways to modify your router's IP address.



## Easy option

**Connection Test screen.** SmartStart tests the connection to the router. While it is testing the connection, a progress indicator screen is displayed and the router's Ethernet LEDs flash.



When the test succeeds, SmartStart indicates success.

If the test fails, the wizard displays an error screen. If the test fails, check the following:

- Check your cable connections. Be sure you have connected the router and the computer properly, using the correct cables. Refer to the Step 1 "Connect the Router" sheet in your Netopia R7200 documentation folio.
- Make sure the router is turned on and that there is an Ethernet connection between your computer and the router.
- Check the TCP/IP control panel settings to be sure that automatic IP Addressing (Windows) or DHCP (Macintosh) is selected. If you are using a Windows PC, SmartStart will automatically detect a static IP address and offer to configure the computer for automatic addressing. On a Macintosh computer, you must manually set the TCP/IP Control Panel to DHCP. See "[Configuring TCP/IP on Macintosh computers](#)" on [page 5-10](#). If you currently use a static IP address outside the 192.168.1.x network, and want to continue using it, use the Advanced option to assign the router an IP address in your target IP range. See "[Advanced option](#)" on [page 5-5](#).
- If all of the above steps fail to resolve the problem, reset the router to its factory default settings and rerun SmartStart. See "[Factory defaults](#)" on [page 15-6](#) for instructions.



When the test is successful, SmartStart presents you with the “Additional Configuration screen,” shown below.

**Additional Configuration screen.** If you have a router that has a permanent unswitched connection to your ISP, such as an IDSL, SDSL, or Ethernet WAN interface router attached to a cable modem, the Additional Configuration screen appears.

You may want to do additional configuration to customize your network environment. SmartStart lets you launch your Telnet application by clicking the Telnet button.

Advanced configuration options available via Telnet are explained in “Console-Based Management” on page 6-1.

However, if you need no further configuration options, click Quit. Congratulations! You’re finished!



## Advanced option

**Router IP Address screen.** If you selected the Advanced option in the “Setup Options screen” on page 5-4, SmartStart asks you to choose between entering the router’s current IP address and assigning an IP address to the router.

If the router has already been assigned an IP address, select the first radio button. If you do this, the “Known IP Address screen,” appears (shown below.)

If you want to reconfigure the router with a new IP address and subnet mask, select the second radio button. If you do this, the “New IP Address screen” on page 5-6 appears.

When you have done this, click Next.



**Known IP Address screen.** SmartStart displays a recommended address for the router based on the IP address of the computer.

If you know the router has an IP address different from the default value, enter it now. Otherwise, accept the recommended address.

When you have done this, click Next.

SmartStart tests the connection to your router.

SmartStart then returns you to an ["Additional Configuration screen"](#) on page 5-5.



**New IP Address screen.** If you want to change the router's IP address, you enter the new IP address, the subnet mask, and the router's serial number in this screen. Remember, the serial number is on the bottom of the router. It is also found in your documentation folio.

Note: Forcing a new IP address may turn off the Netopia R7200's IP address serving capabilities, if you assign an IP address and subnet mask outside the router's current IP address serving pool. The Netopia R7200 does not allow an invalid address to be served. Use this option with caution.

When you have done this, click Next.

SmartStart forces the new IP address into the router, tests the connection, and then resets the router.

SmartStart then returns you to the ["Additional Configuration screen"](#) on page 5-5.



---

## *Sharing the Connection*

### *Configuring TCP/IP on Windows 95, 98, or NT computers*

Configuring TCP/IP on a Windows computer requires the following:

- An Ethernet card (also known as a network adapter)
- The TCP/IP protocol must be "bound" to the adapter or card

### Dynamic configuration (recommended)

If you configure your Netopia R7200 using SmartStart, you can accept the dynamic IP address assigned by your router. The Dynamic Host Configuration Protocol (DHCP) server, which enables dynamic addressing, is enabled by default in the router. If your PC is not set for dynamic addressing, SmartStart will offer to do this for you when you launch it. In that case, you will have to restart your PC and relaunch SmartStart. If you configure your PC for dynamic addressing in advance, SmartStart need only be launched once. To configure your PC for dynamic addressing do the following:

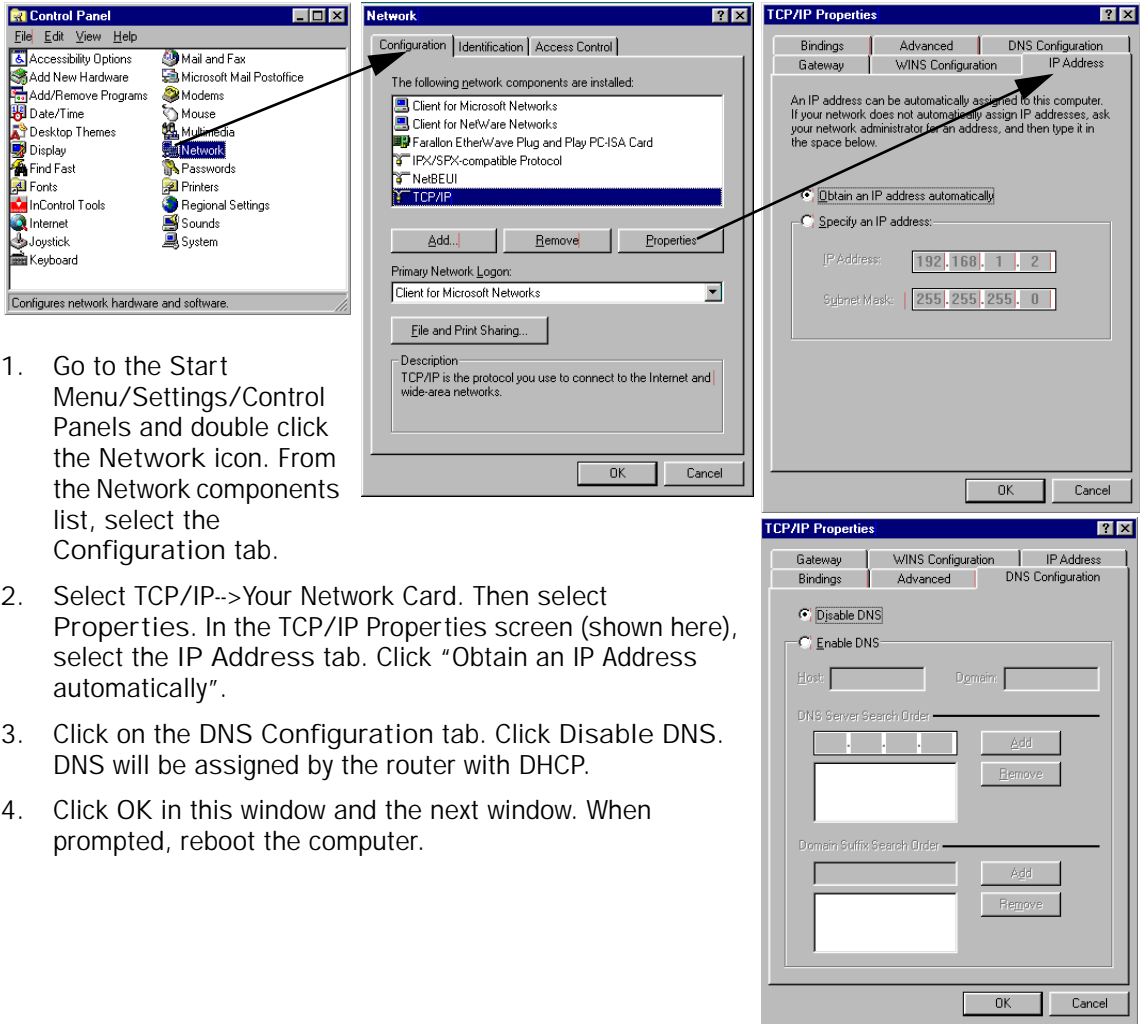

1. Go to the Start Menu/Settings/Control Panels and double click the Network icon. From the Network components list, select the Configuration tab.
2. Select TCP/IP-->Your Network Card. Then select Properties. In the TCP/IP Properties screen (shown here), select the IP Address tab. Click "Obtain an IP Address automatically".
3. Click on the DNS Configuration tab. Click Disable DNS. DNS will be assigned by the router with DHCP.
4. Click OK in this window and the next window. When prompted, reboot the computer.

Note: You can also use these instructions to configure other computers on your network to accept IP addresses served by the Netopia R7200.

## 5-8 User's Reference Guide

### Static configuration (optional)

If you are manually configuring for a fixed or static IP address, perform the following:

1. Go to Start Menu/Settings/Control Panels and double click the Network icon. From the Network components list, select the Configuration tab.
2. Select TCP/IP-->Your Network Card. Then select Properties. In the TCP/IP Properties screen (shown below), select the IP Address tab. Click "Specify an IP Address."

Enter the following:

IP Address: 192.168.1.2

Subnet Mask: 255.255.255.0, or for 12-user models 255.255.255.240

This address is an example of one that can be used to configure the router with the Easy option in the SmartStart Wizard. Your ISP or network administrator may ask you to use a different IP address and subnet mask.

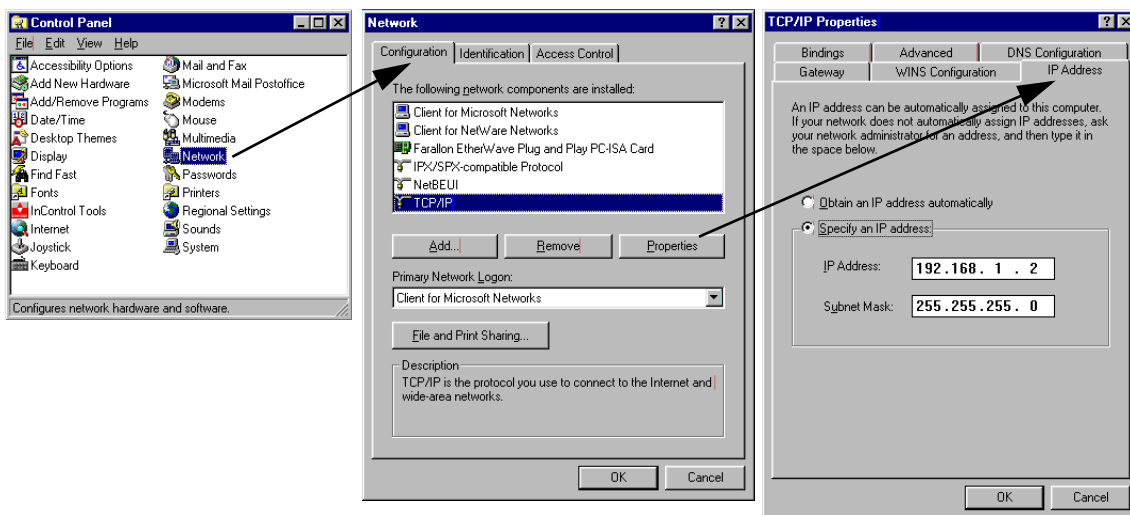

3. Click on the Gateway tab (shown below). Under "New gateway," enter 192.168.1.1. Click Add. This is the Netopia R7200's pre-assigned IP address.

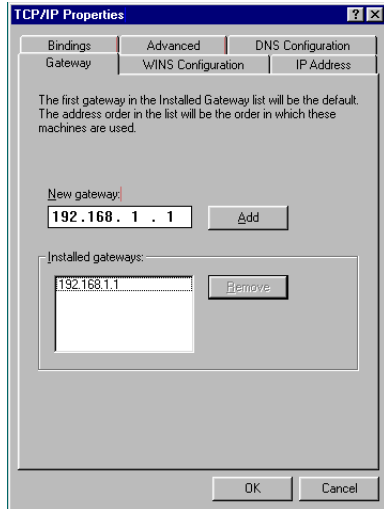

Click on the DNS Configuration tab. Click Enable DNS. Enter the following information:

Host: Type the name you want to give to this computer.

Domain: Type your domain name. If you don't have a domain name, type your ISP's domain name; for example, netopia.com.

DNS Server Search Order: Type the primary DNS IP address given to you by your ISP. Click Add. Repeat this process for the secondary DNS.

Domain Suffix Search Order: Enter the same domain name you entered above.

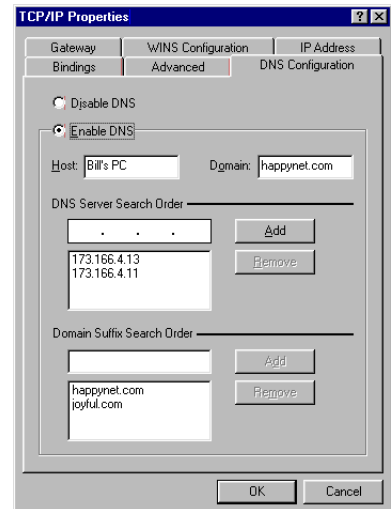

4. Click OK in this window and the next window. When prompted, reboot the computer.

Note: You can also use these instructions to configure other computers on your network with manual or static IP addresses. Be sure each computer on your network has its own IP address.

## Configuring TCP/IP on Macintosh computers

The following is a quick guide to configuring TCP/IP for MacOS computers. Configuring TCP/IP in a Macintosh computer requires the following:

- You must have either Open Transport or Classic Networking (MacTCP) installed.

Note: If you want to use the Dynamic Host Configuration Protocol (DHCP) server built into your Netopia R7200 to assign IP addresses to your Macintoshes, you must be running Open Transport, standard in MacOS 8 and optional in earlier system versions. You can have your Netopia R7200 dynamically assign IP addresses using MacTCP; however, to do so requires that the optional AppleTalk kit be installed which can only be done after the router is configured.

- You must have built-in Ethernet or a third-party Ethernet card and its associated drivers installed in your Macintosh.

### Dynamic configuration (recommended)

If you configure your Netopia R7200 using SmartStart, you can accept the dynamic IP address assigned by your router. The Dynamic Host Configuration Protocol (DHCP), which enables dynamic addressing, is enabled by default in the router. To configure your Macintosh computer for dynamic addressing do the following:

1. Go to the Apple menu. Select Control Panels and then TCP/IP.
2. With the TCP/IP window open, go to the Edit menu and select User Mode. Choose Basic and click OK.
3. In the TCP/IP window, select "Connect via: Ethernet" and "Configure: Using DHCP Server."

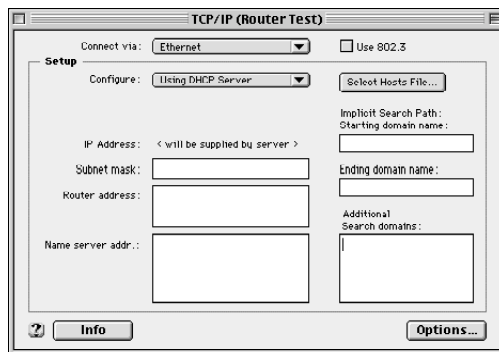

Note: You can also use these instructions to configure other computers on your network to accept IP addresses served by the Netopia R7200.

Static configuration (optional)

If you are manually configuring for a fixed or static IP address, perform the following:

1. Go to the Apple menu. Select Control Panels and then TCP/IP or MacTCP.
2. With the TCP/IP window open, go to the Edit menu and select User Mode. Choose Advanced and click OK.

Or, in the MacTCP window, select Ethernet and click the More button.

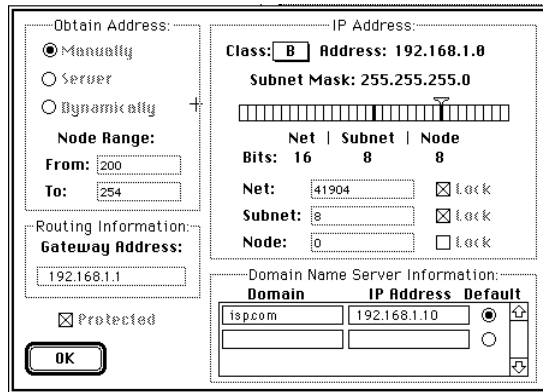
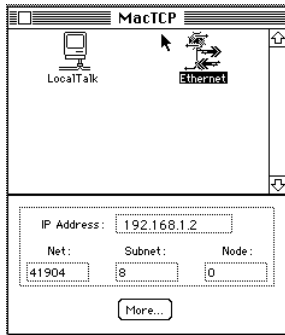
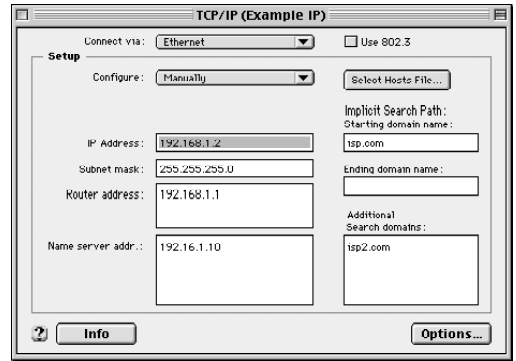

3. In the TCP/IP window or in the MacTCP/More window, select or type information into the fields as shown in the following table.

Option:	Select/Type:
Connect via:	Ethernet
Configure:	Manually
IP Address:	192.168.1.2
Subnet mask:	255.255.255.0, or for 12-user models 255.255.255.240
Router or Gateway address:	192.168.1.1
Name server address:	Enter the primary and secondary name server addresses given to you by your ISP
Implicit Search Path:	Enter your domain name; if you do not have a domain name, enter the domain name of your ISP
Starting domain name:	

4. Close the TCP/IP or MacTCP control panel and save the settings.
5. If you are using MacTCP, you must restart the computer. If you are using Open Transport, you do not need to restart.

Note: You can also use these instructions to configure other computers on your network with manual or static IP addresses. Be sure each computer on your network has its own IP address.

*Dynamic configuration using MacIP (optional)*

If you want to use MacIP to dynamically assign IP addresses to the Macintosh computers on your network you must install the optional AppleTalk feature set kit.

**Note:** You cannot use MacIP dynamic configuration to configure your Netopia R7200 SDSL Router because you must first configure the router in order to enable AppleTalk.

Once the AppleTalk kit is installed, you can configure your Macintoshes for MacIP. To configure dynamically using MacIP, perform the following:

**Using Open Transport TCP/IP**

1. Go to the Apple menu. Select **Control Panels** and then **TCP/IP**.
2. With the TCP/IP window open, go to the Edit menu and select **User Mode**. Choose **Advanced** and click **OK**.

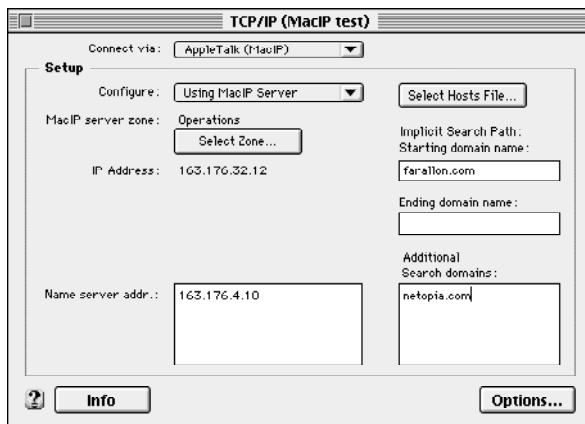

3. In the TCP/IP window, select or type information into the fields as shown in the following table.

TCP/IP Option:	Select/ Type:
Connect via:	AppleTalk (MacIP)
Configure:	Using MacIP server
MacIP Server zone:	(select available zone)
Name server address:	Enter the primary and secondary name server addresses given to you by your ISP
Implicit Search Path:	Enter your domain name; if you do not have a domain name, enter the domain name of your ISP
Starting domain name:	

4. Close the TCP/IP control panel and save the settings.

These are the only fields you need to modify in these screens.



## Using Classic Networking (MacTCP)

1. Go to the Apple Menu. Select **Control Panels** and then **Network**.
2. In the Network window, select **EtherTalk**.

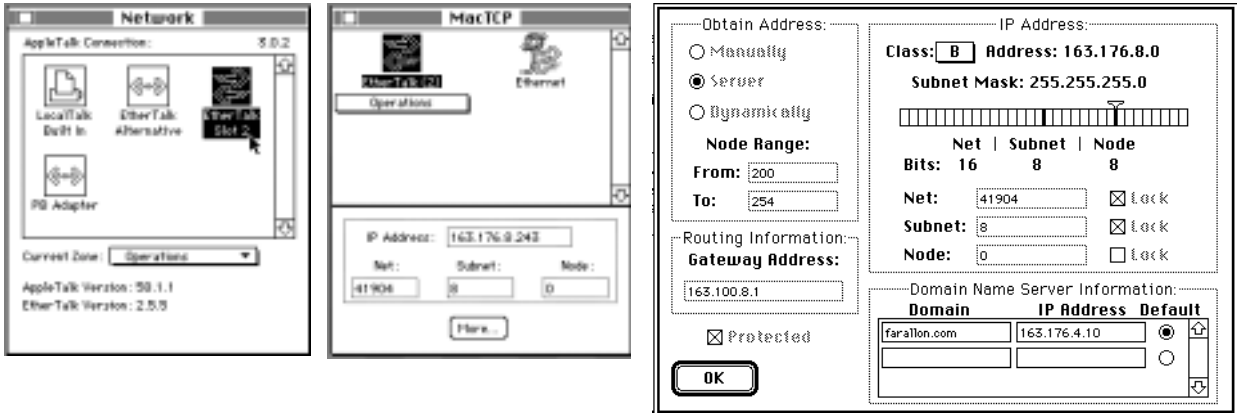

3. Go back to the Apple menu. Select **Control Panels** and then **MacTCP**.
4. Select **EtherTalk**.

From the pull-down menu under EtherTalk, select an available zone; then click the **More** button.

In the MacTCP/More window select the **Server** radio button. If necessary, fill in the Domain Name Server information given to you by your administrator.

5. Restart the computer.

**Note:** More information about configuring your Macintosh computer for TCP/IP connectivity through a Netopia R7200 can be found in Technote NIR\_026, "Open Transport and Netopia Routers," located on the Netopia Web site.



## Chapter 6

# Console-Based Management

Console-based management is a menu-driven interface for the capabilities built into the Netopia R7200. Console-based management provides access to a wide variety of features that the router supports. You can customize these features for your individual setup. This chapter describes how to access the console-based management screens.

This section covers the following topics:

- “Connecting through a Telnet session” on page 6-2
- “Connecting a console cable to your router” on page 6-3
- “Navigating through the console screens” on page 6-4

Console-based management screens contain seven entry points to the Netopia Router configuration and monitoring features. The entry points are displayed in the Main Menu shown below:

```
Netopia R7200 v4.3.5

Easy Setup...
WAN Configuration...
System Configuration...
Utilities & Diagnostics...
Statistics & Logs...
Quick Menus...
Quick View...

Return/Enter goes to Easy Setup -- minimal configuration.
You always start from this main screen.
```

- The **Easy Setup** menu display and permit changing the values contained in the default connection profile. Experienced users can use Easy Setup to initially configure the router directly through a console session. Easy Setup menus contain up to five descendant screens for viewing or altering these values. The number of screens depends on whether you have optional features installed.
- The **WAN Configuration** menu displays and permits changing your connection profile(s) and default profile, creating or deleting additional connection profiles, and configuring or reconfiguring the manner in which you

may be using the router to connect to more than one service provider or remote site.

- The **System Configuration** menus display and permit changing:
  - Network protocols setup. See ["IP Setup and Network Address Translation"](#) on page 10-1, ["IPX Setup"](#) on page 11-1, and ["AppleTalk Setup"](#) on page 12-1.
  - Filter sets (firewalls). See ["Security"](#) on page 14-1.
  - IP address serving. See ["IP address serving"](#) on page 10-21.
  - Date and time. See ["Date and time"](#) on page 8-12.
  - Console configuration. See ["Connecting a console cable to your router"](#) on page 6-3.
  - SNMP (Simple Network Management Protocol). See ["SNMP"](#) on page 13-12.
  - Security. See ["Security"](#) on page 14-1.
  - Upgrade feature set. See ["Upgrade feature set"](#) on page 8-14.
- The **Utilities & Diagnostics** menus provide a selection of seven tools for monitoring and diagnosing the router's behavior, as well as for updating the firmware and rebooting the system. See ["Utilities and Diagnostics"](#) on page 15-1 for detailed information.
- The **Statistics & Logs** menus display nine sets of tables and device logs that show information about your router, your network, and their history. See ["Statistics & Logs"](#) on page 13-4 for detailed information.
- The **Quick Menus** screen is a shortcut entry point to 22 of the most commonly used configuration menus that are accessed through the other menu entry points.
- The **Quick View** menu displays at a glance current real-time operating information about your router. See ["Quick View status overview"](#) on page 13-1 for detailed information.

---

### *Connecting through a Telnet session*

Features of the Netopia R7200 can be configured through the console screens.

Before you can access the console screens through Telnet, you must have:

- A network connection locally to the router or IP access to the router.

**Note:** Alternatively, you can have a direct serial console cable connection using the provided console cable for your platform (PC or Macintosh) and the Console port on the back of the router. For more information on attaching the console cable, see ["Connecting a console cable to your router"](#) on page 6-3.

- Telnet software installed on the computer you will use to configure the router

## Configuring Telnet software

If you are configuring your router using a Telnet session, your computer must be running a Telnet software program.

- If you connect a PC with Microsoft Windows, you can use a Windows Telnet application or simply run Telnet from the Start menu.
- If you connect a Macintosh computer, you can use the NCSA Telnet program supplied on the Netopia R7200 CD. You install NCSA Telnet by simply dragging the application from the CD to your hard disk.

---

## Connecting a console cable to your router

You can perform all of the system configuration activities for your Netopia R7200 through a local serial console connection using terminal emulation software, such as HyperTerminal provided with Windows 95 on the PC, or ZTerm, included on the Netopia CD, for Macintosh computers.

The Netopia R7200 back panel has a connector labeled "Console" for attaching the Router to either a PC or Macintosh computer via the serial port on the computer. (On a Macintosh computer, the serial port is called the Modem port or Printer port.) This connection lets you use the computer to configure and monitor the Netopia R7200 via the console screens.

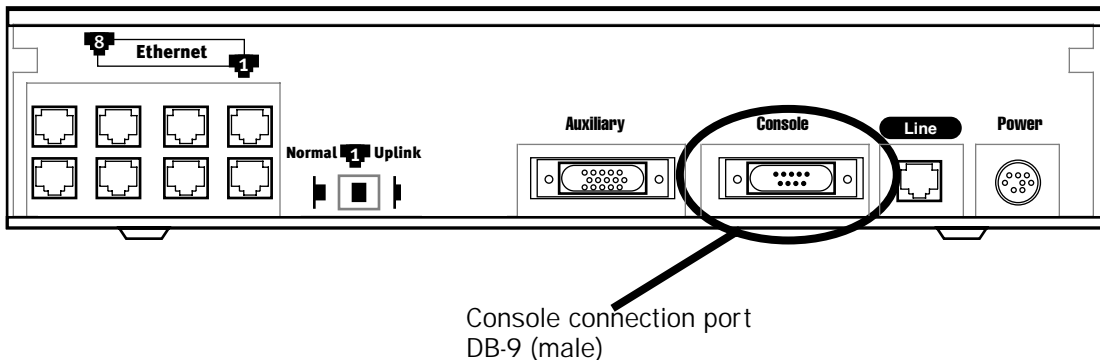

To connect the Netopia R7200 to your computer for serial console communication, use the supplied dual console cable connector end appropriate to your platform:

- One DB-9 connector end attaches to a PC.
- The mini-DIN8 connector end attaches to a Macintosh computer.
- The DB-9 end of the Console cable attaches to the Netopia R7200's Console port.
- If you connect a PC with Microsoft Windows 95 or NT, you can use the HyperTerminal application bundled with the operating system.
- If you connect a Macintosh computer, you can use the ZTerm terminal emulation program on the supplied Netopia R7200 CD.

## 6-4 User's Reference Guide

Launch your terminal emulation software and configure the communications software for the values shown in the table below. These are the default communication parameters that the Netopia R7200 uses.

Parameter	Suggested Value
Terminal type	<b>PC:</b> ANSI-BBS <b>Mac:</b> ANSI, VT-100, or VT-200
Data bits	8
Parity	None
Stop bits	1
Speed	57600 bits per second
Flow Control	None
<b>Note:</b> The router firmware contains an autobaud detection feature. If you are at any screen on the serial console, you can change your baud rate and press Return (HyperTerminal for the PC requires a disconnect). The new baud rate is displayed at the bottom of the screen.	

---

### *Navigating through the console screens*

Use your keyboard to navigate the Netopia R7200's configuration screens, enter and edit information, and make choices. The following table lists the keys to use to navigate through the console screens.

To...	Use These Keys...
Move through selectable items in a screen or pop-up menu	Up, Down, Left, and Right Arrow
Set a change to a selected item or open a pop-up menu of options for a selected item like entering an upgrade key	Return or Enter
Change a toggle value (Yes/No, On/Off)	Tab
Restore an entry or toggle value to its previous value	Esc
Move one item up	Up arrow or Control + K
Move one item down	Down arrow or Control + O
Display a dump of the device event log	Control + E
Display a dump of the WAN event log	Control + F
Refresh the screen	Control + L
Go to topmost selectable item	<
Go to bottom right selectable item	>

# Chapter 7

## Easy Setup

This chapter describes how to use the Easy Setup console screens on your Netopia R7200 SDSL Router. After completing the Easy Setup console screens, your router will be ready to connect to the Internet or another remote site.

---

### *Easy Setup console screens*

Using four Easy Setup console screens, you can:

- Modify a connection profile for your router for the connection to your ISP or remote location
- Set up IP addresses and IP address serving
- Password-protect configuration access to your Netopia R7200 SDSL Router

### *Accessing the Easy Setup console screens*

To access the console screens, Telnet to the Netopia Router over your Ethernet network or physically connect with a serial console cable and access the Netopia Router with a terminal emulation program. See [“Connecting through a Telnet session” on page 6-2](#) or [“Connecting a console cable to your router” on page 6-3](#).

**Note:** Before continuing, make sure you have the information that your telephone service provider, ISP, or network administrator has given you for configuring the Netopia Router.

The Netopia Router’s first console screen, Main Menu, appears in the terminal emulation window of the attached PC or Macintosh computer when:

- The Netopia Router is turned on
- The computer is connected to the Netopia Router
- Telnet or the terminal emulation software is running and configured correctly

A screen similar to the following Main Menu appears:

```
Netopia R7200 v4.3.5

Easy Setup...
WAN Configuration...
System Configuration...
Utilities & Diagnostics...
Statistics & Logs...
Quick Menus...
Quick View...

Return/Enter goes to Easy Setup -- minimal configuration.
You always start from this main screen.
```

If you do not see the Main Menu, verify that:

- The computer used to view the console screen has its serial port connected to the Netopia R7200's Console port or an Ethernet connection to one of its Ethernet ports. See ["Connecting a console cable to your router" on page 6-3](#) or ["Connecting through a Telnet session" on page 6-2](#).
- Telnet or the terminal emulation software is configured for the recommended values.
- If you are connecting via the Console port, your computer's serial port is not being used by another device, such as an internal modem, or an application. Turn off all other programs (other than your terminal emulation program) that may be interfering with your access to the port.
- You have entered the correct password, if necessary. Your Netopia R7200's console access may be password protected from a previous configuration. See your system administrator to obtain the password. See [Appendix A, "Troubleshooting,"](#) for more suggestions.



---

## Quick Easy Setup connection path

This section may be all you need to do to configure your Netopia R7200 SDSL Router to connect to the Internet. Most ISPs will supply you with several parameter values for you to enter in the router. The ISP will provide the values shown below:

Parameter:		Your value:
Data Link Encapsulation	RFC1483 (default) or PPP (optional)	
Local WAN IP Address	n/a	
Local WAN IP Mask	n/a	
Default IP Gateway	n/a	
Domain Name	n/a	
Primary Domain Name Server	n/a	
User Name	n/a	
Password	n/a	

(If you want to record these values, you can print this page and use the spaces above.)

If your ISP assigns your Router a Static IP address, do the following:

1. Open a Telnet session to 192.168.1.1 to bring up the Main Menu.

If you don't know how to do this, see ["Connecting through a Telnet session"](#) on page 6-2.

Alternatively, you can connect the console cable and open a direct serial console connection, using a terminal emulator program. See ["Connecting a console cable to your router"](#) on page 6-3.

## 7-4 User's Reference Guide

The Main Menu appears.

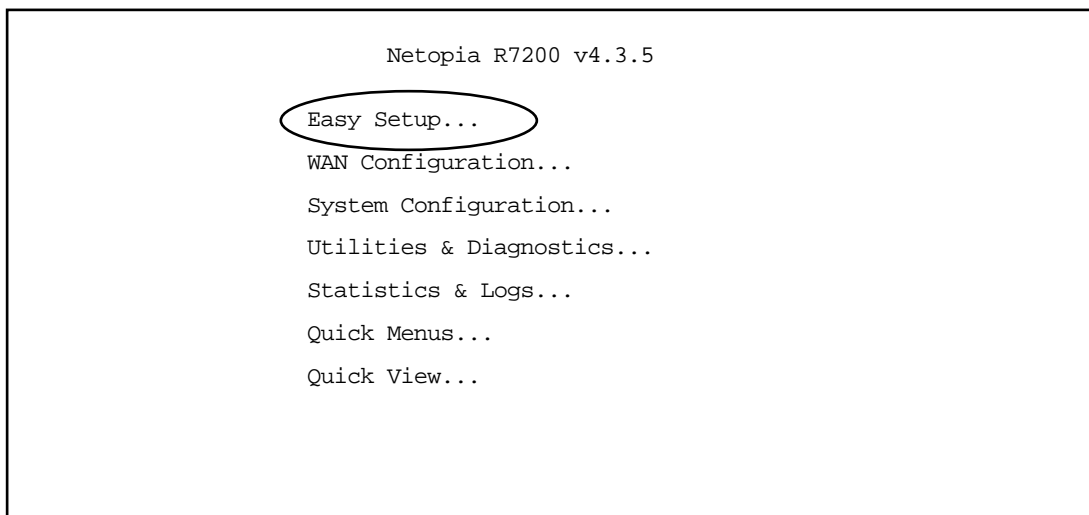

2. Select the first item on the Main Menu list, **Easy Setup**. Press Return to bring up the SDSL Line Configuration menu screen.

### *SDSL Line Configuration*

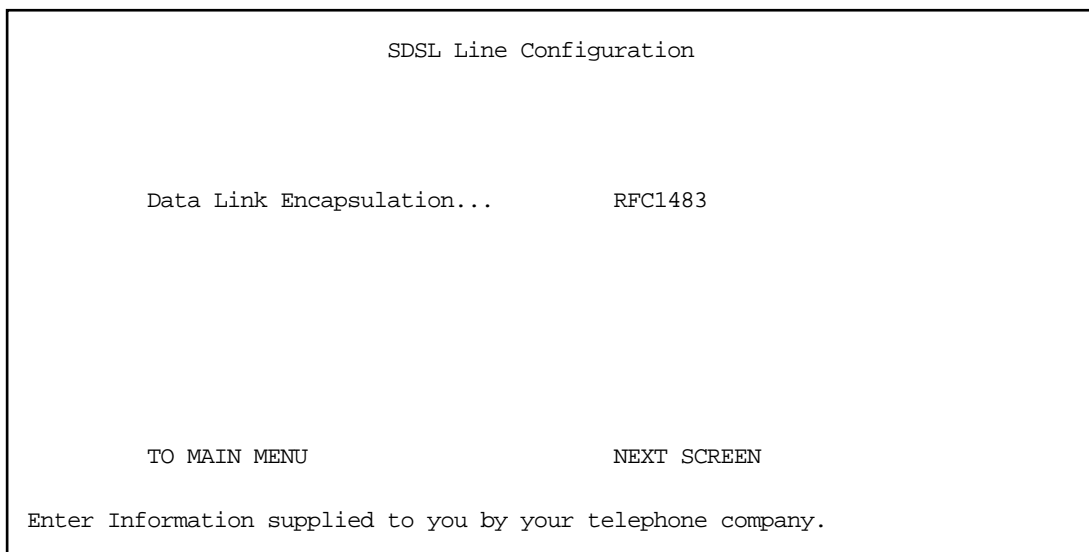

1. Select **Data Link Encapsulation** and press Return. The pop-up menu will offer you the choice of PPP or RFC1483. Your selection depends on which type your ISP uses. The default is RFC1483.
2. Press the Down arrow key until you reach **NEXT SCREEN**. Press Return to bring up the next screen.

## Easy Setup Profile

The Easy Setup Profile screen is where you configure the parameters that control the Netopia R7200's connection to a specific remote destination, usually your ISP or a corporate site.

On a Netopia R7200 SDSL Router you can add up to 15 more connection profiles, for a total of 16, although you can only use one at a time.

Connection Profile 1: Easy Setup Profile

Address Translation Enabled:	Yes
Local WAN IP Address:	0.0.0.0
Remote IP Address:	127.0.0.2
Remote IP Mask:	255.255.255.255
PPP Authentication...	PAP
Send User Name:	jarjar
Send Password:	binks

PREVIOUS SCREEN	NEXT SCREEN
-----------------	-------------

Return accepts \* ESC cancels \* Left/Right moves insertion point \* Del deletes.  
Enter basic information about your WAN connection with this screen.

1. To enable address translation, toggle **Address Translation Enabled** to **Yes** (the default). For more information on Network Address Translation, see [Chapter 10, "IP Setup and Network Address Translation," on page 10-1](#).

If you selected RFC1483 data link encapsulation in the SDSL Line Configuration screen, an **IP Addressing** menu item appears allowing you to choose between Unnumbered and Numbered addressing. Numbered is the default for SDSL. It assigns a unique IP address to the SDSL WAN interface, as required by most ISPs' routers. Unnumbered may be used for simpler configurations such as point-to-point short haul applications.

2. Select the editable field labeled **Local WAN IP Address**.

The default address is 0.0.0.0, which allows for dynamic addressing, when your ISP assigns an address each time you connect. However, you can enter another specific address if you want to use static addressing. In that case, enter the local WAN address your ISP gave you. Press Return.

3. If you selected PPP data link encapsulation in the SDSL Line Configuration screen, a PPP Authentication menu item appears. The authentication protocol and user name/password combinations you enter must be assigned or agreed to in advance between you and your ISP. Select **PPP Authentication** and press Return.

From the pop-up menu that appears, select the authentication method your ISP uses: PAP (Password Authentication Protocol), CHAP (Challenge Handshake Authentication Protocol), PAP-TOKEN, CACHE-TOKEN, or None.

- PAP is the most common, and requires you to enter a User Name and Password in the next two fields.

## 7-6 User's Reference Guide

- CHAP requires you to enter a Host Name and Secret in the next two fields.
  - PAP-TOKEN requires you to enter a User Name in the next field.
  - CACHE-TOKEN requires you to enter a User Name and Password in the next two fields.
4. Press the Down arrow key until you reach **NEXT SCREEN**. Press Return to bring up the next screen.

### IP Easy Setup

The IP Easy Setup screen is where you enter information about your Netopia Router's:

- Ethernet IP address
- Ethernet Subnet mask
- Domain Name
- Domain Name Server IP address
- Default gateway IP address

Consult with your network administrator to obtain the information you will need. For more information about setting up IP, see ["IP Setup and Network Address Translation"](#) on page 10-1.

IP Easy Setup	
Ethernet IP Address:	192.168.1.1
Ethernet Subnet Mask:	255.255.255.0
Domain Name:	isp.net
Primary Domain Name Server:	209.3.224.21
Secondary Domain Name Server:	209.3.224.20
Default IP Gateway:	127.0.0.2
IP Address Serving:	On
Number of Client IP Addresses:	100
1st Client Address:	192.168.1.100
PREVIOUS SCREEN	NEXT SCREEN

Enter an IP address in decimal and dot form (xxx.xxx.xxx.xxx).  
Set up the basic IP & IPX attributes of your Netopia in this screen.

1. Select **Ethernet IP Address** and enter the first IP address from the IP address range your ISP has given you. This will be the Netopia Router's IP address.

If Network Address Translation is enabled in the Easy Setup connection profile, the Ethernet IP Address defaults to an address (192.168.1.1) within a range reserved by the Internet address administration authority for use within private networks.

Because this is a private network address, it should never be directly connected to the Internet. Using NAT for all your connection profiles will ensure this restriction. See ["IP Setup and Network Address Translation"](#) on page 10-1 of this guide for more information.

2. Select **Ethernet Subnet Mask** and enter the subnet mask your ISP has given you. The Ethernet Subnet Mask defaults to a standard class mask derived from the class of the Ethernet IP address you entered in the previous step.
3. Press the Down arrow key until the editable field labeled **Domain Name** is highlighted.
4. Type the Domain Name your ISP gave you. Press Return. The next field **Primary Domain Name Server** will be highlighted.
5. Type the Primary Domain Name Server address your ISP gave you. Press Return. A new field **Secondary Domain Name Server** will appear. If your ISP gave you a secondary domain name server address, enter it here. Press Return until the next field **Default IP Gateway** is highlighted.
6. If you do not enter a **Default IP Gateway** value, the router defaults to the remote IP address you entered in the Easy Setup connection profile. If the Netopia Router does not recognize the destination of any IP traffic, it forwards that traffic to this gateway.

Do not confuse the remote IP address and the Default IP Gateway's address with the block of local IP addresses you receive from your ISP. You use the local IP addresses for the Netopia R7200's Ethernet port and for IP clients on your local network. The remote IP address and the default gateway's IP address should point to your ISP's router.

7. Press the Down arrow key until you reach **NEXT SCREEN**. Press Return.

## *Easy Setup Security Configuration*

The Easy Setup Security Configuration screen lets you password-protect your Netopia R7200. Input your **Write Access Name** and **Write Access Password** with names or numbers totaling up to eleven digits.

If you password protect the console screens, you will be prompted to enter the name and password you have specified every time you log in to the console screens. Do not forget your name and password. If you do, you will be unable to access any of the configuration screens.

Additional security features are available. See "[Security](#)" on page 14-1.

Easy Setup Security Configuration

It is strongly suggested that you password-protect configuration access to your Netopia. By entering a Name and Password pair here, access via serial, Telnet, SNMP and Web Server will be password-protected.

Be sure to remember what you have typed here, because you will be prompted for it each time you configure this Netopia.

You can remove an existing Name and Password by clearing both fields below.

Write Access Name:

Write Access Password:

PREVIOUS SCREEN

TO MAIN MENU

RESTART DEVICE

Configure a Configuration Access Name and Password here.

The final step in configuring the Easy Setup console screens is to restart the Netopia R7200, so that the configuration settings take effect.

1. Select **RESTART DEVICE**. A prompt asks you to confirm your choice.
2. Select **CONTINUE** to restart the Netopia Router and have your selections take effect.

**Note:** You can also restart the system at any time by using the Restart System utility (see ["Restarting the system" on page 15-12](#)) or by turning the Netopia Router off and on with the power switch.

The Router will restart and your configuration settings will be activated. You can then Exit or Quit your Telnet application.

Easy Setup is now complete.

## ***Part II: Advanced Configuration***





## Chapter 8

# WAN and System Configuration

This chapter describes how to use the console-based management screens to access and configure advanced features of your Netopia R7200 SDSL Router. You can customize these features for your individual setup. These menus provide a powerful method for experienced users to set up their router's connection profiles and system configuration.

This section covers the following topics:

- "WAN configuration" on page 8-1
- "Creating a new Connection Profile" on page 8-3
- "The default profile" on page 8-6
- "System configuration screens" on page 8-9
- "Navigating through the system configuration screens" on page 8-10
- "System configuration features" on page 8-11

---

### WAN configuration

To configure your Wide Area Network (WAN) connection, navigate to the WAN Configuration screen from the Main Menu and select **WAN Configuration**, then **SDSL Line Configuration**.

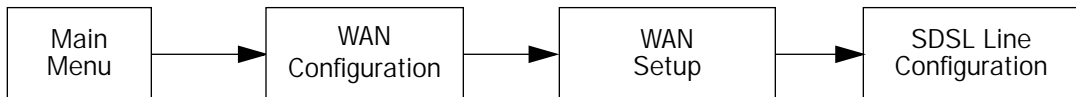

The SDSL Line Configuration screen appears.

SDSL Line Configuration	
Data Rate Mode...	Hunt
Data Rate...	384
ATM VPI:	0
ATM VCI:	38
Data Link Encapsulation...	RFC1483
Aux Serial Port...	Async Modem
Data Rate (kbps)...	57.6
Aux Modem Init String:	AT&F&C1&D2E0S0=1

Enter Information supplied to you by your telephone company.

- The **Data Rate Mode** pop-up menu offers the choice of Hunt or Locked mode.
  - If you select **Hunt** (the default) the router will attempt to connect at the data rate you specify in the Data Rate selection, but if it cannot do so, it will then hunt through all the available data rates until it finds one at which it can establish a connection. When it does establish a connection, it will store that data rate and use it the next time you connect.
  - If you select **Locked**, the router will always attempt to connect at the data rate you select in the next step.
- The **Data Rate** pop-up menu allows you to set the initial or locked data rate for the SDSL link (and the attached CPE device). The pop-up menu offers you a choice of connection speeds: 192, 384 (the default), 768, 1152, or 1536Kbps.
- The **ATM VPI** (Virtual Path Identifier) is used to route information from one switch to another. VCI and VPI, below, are not addresses. They are explicitly assigned at each segment within a network. In most cases the default value of 0 (zero) can be used, unless you are otherwise advised by your ISP or exchange carrier (CLEC).
- The **ATM VCI** (Virtual Channel Identifier) value is used to identify a connection between two ATM switches. In most cases the default value of 38 can be used, unless you are otherwise advised by your ISP or exchange carrier (CLEC).
- Select **Data Link Encapsulation** and press Return. The pop-up menu will offer you the choice of PPP or RFC1483. Your selection depends on which type your ISP uses. The default is RFC1483.
- By default, the **Auxiliary Serial Port** is enabled it for an asynchronous modem. If the AppleTalk feature set is installed, then LocalTalk becomes the default option. You can also specify it to be Unused.
- For modem applications, a **Data Rate** pop-up offers a limited set of serial data rates. 57.6 is the default setting.
- If you have attached an external modem, you can specify a **Modem Init String**. Consult your modem's documentation for the correct init string for your modem. If you have enabled the optional AppleTalk

feature, the modem options are hidden.

## Creating a new Connection Profile

For a Netopia R7200, connection profiles are useful for configuring the connection and authentication settings for negotiating a PPP connection on the SDSL link or on an asynchronous modem attached to the Auxiliary port. If you are using the PPP data link encapsulation method, you can store your authentication information in the connection profile so that your user name and password (or host name and secret) are transmitted when you attempt to connect.

Connection profiles define the networking protocols necessary for the router to make a remote connection. A connection profile is like an address book entry describing how the router is to get to a remote site, or how to recognize and authenticate a connection. To create a new connection profile, you navigate to the WAN Configuration screen from the Main Menu, and select **Add Connection Profile**.

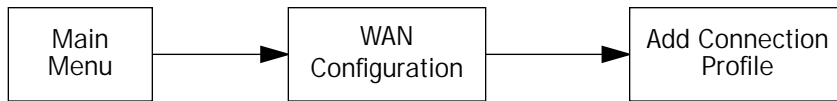

The **Add Connection Profile** screen appears.

Add Connection Profile	
Profile Name:	Profile 01
Profile Enabled:	Yes
IP Enabled:	Yes
IP Profile Parameters...	
IPX Enabled:	No
Data Link Encapsulation...	RFC1483
Interface Group...	Primary
ADD PROFILE NOW	CANCEL
Configure a new Conn. Profile. Finished? ADD or CANCEL to exit.	

On a Netopia R7200 SDSL Router you can add up to 15 more connection profiles, for a total of 16, but you can only use one at a time.

1. Select **Profile Name** and enter a name for this connection profile. It can be any name you wish. For example: the name of your ISP.
2. Toggle **Profile Enabled** to **Yes** or **No**. The default is Yes.

3. Select **IP Profile Parameters** and press Return. The IP Profile Parameters screen appears.

```

                                IP Profile Parameters

Address Translation Enabled:      Yes

Local WAN IP Address:           0.0.0.0
Remote IP Address:              0.0.0.0
Remote IP Mask:                 0.0.0.0

Filter Set...
Remove Filter Set

Receive RIP:                     Off

Toggle to Yes if this is a single IP address ISP account.
Configure IP requirements for a remote network connection here.
```

4. Toggle or enter any IP Parameters you require and return to the Add Connection Profile screen by pressing Escape. For more information, see ["IP Setup and Network Address Translation"](#) on page 10-1.
5. If you will be connecting with an IPX remote network, toggle **IPX Enabled** to Yes, and press Return. Otherwise, accept the default No.

If you enable IPX routing, an **IPX Profile Parameters** menu item becomes available. Select IPX Profile Parameters and press Return. The IPX Profile Parameters screen appears.

```

                                IPX Profile Parameters

Remote IPX Network:             00000000
Path Delay:                     10
NetBios Packet Forwarding:     Off

Incoming Packet Filter Set...   <<NONE>>
Outgoing Packet Filter Set...   <<NONE>>

Incoming SAP Filter Set...      <<NONE>>
Outgoing SAP Filter Set...      <<NONE>>

Periodic RIP Timer:            60
Periodic SAP Timer:            60

Configure IPX requirements for a remote network connection here.
```

6. Toggle or enter any IPX Parameters you require and return to the Add Connection Profile screen by pressing Escape. For more information, see "IPX Setup" on page 11-1.
7. Select **Data Link Encapsulation** and press Return. From the pop-up menu select either **PPP** or **RFC1483**. If you select PPP, the Data Link Options menu item is displayed; if you select RFC1483, the Data Link Options item is hidden.
8. If you chose PPP as your data link encapsulation method in the previous step, select **Datalink Options** and press Return. The Datalink Options screen appears.

Datalink (PPP/MP) Options

Data Compression...	Standard LZS
Send Authentication...	PAP
Send User Name:	
Send Password:	
Receive User Name:	
Receive Password:	
Maximum Packet Size:	1500

In this Screen you will configure the PPP/MP specific connection params.

Select **Data Compression** and press Return. The pop-up menu offers the choices of None, Ascend LZS, or Standard LZS (the default). Unless you are otherwise specifically directed, you can accept the default.

Select **Send Authentication** and press Return.

From the pop-up menu that appears, select the authentication method your ISP uses, if any: PAP (Password Authentication Protocol), CHAP (Challenge Handshake Authentication Protocol), PAP-TOKEN, CACHE-TOKEN, or None.

- PAP is the most common, and requires you to enter a User Name and Password in the next two fields.
- CHAP requires you to enter a Host Name and Secret in the next two fields.
- PAP-TOKEN requires you to enter a User Name in the next field.
- CACHE-TOKEN requires you to enter a User Name and Password in the next two fields.

You can specify user name and password for both outgoing and incoming calls. the Send User Name/Password parameters are used to specify your identity when connecting to a remote location. The Receive User Name/Password parameters are used when receiving dial-in clients such as via RAS configuration.

9. You can edit the **Maximum Packet Size** field, if you want packets limited to a lower value than 1500. Return to the Add Connection Profile screen by pressing Escape.

## 8-6 User's Reference Guide

10. Select **Interface Group** and press Return. From the pop-up menu select either **Primary** or **Backup**. If you select Primary, the profile is applied to your primary WAN interface (the SDSL link). This would be desirable if you were creating a profile to store your authentication information for a PPP connection over the SDSL link. If you select Backup, the profile is applied to your backup interface.
11. Select **ADD PROFILE NOW** and press Return. Your new Connection Profile will be added.

If you want to view the Connection Profiles in your router, return to the WAN Configuration screen, and select **Display/Change Connection Profile**. The list of Connection Profiles is displayed in a scrolling pop-up screen.

```
WAN Configuration
+-Profile Name-----IP Address---IPX Network--+
+-----+-----+-----+
SmartStart Profile      127.0.0.2
Profile 02              0.0.0.0
+-----+-----+-----+

Up/Down Arrow Keys to select, ESC to dismiss, Return/Enter to Edit.
```

---

### The default profile

If you are using RFC1483 datalink encapsulation, the Default Profile screen controls whether or not the SDSL link will come up without an explicitly configured connection profile. (PPP datalink encapsulation does not support a default profile, and the corresponding menu item is unavailable.) See ["Connection Profiles" on page 10-8](#) for more information.

You access the Default Profile screen from the Main Menu by selecting WAN Configuration and then selecting **Default Profile**.

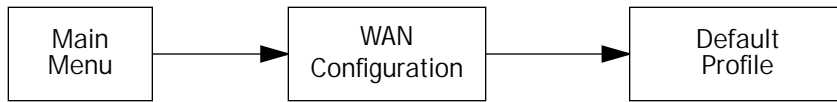

The Default Profile screen appears.

Default Profile	
Must Match a Defined Profile:	No
IP Enabled:	Yes
IP Parameters...	
IPX Enabled:	Yes
IPX Parameters...	
Return/Enter accepts * Tab toggles * ESC cancels. Configure Default WAN Connection Parameters here.	

- You can set Must Match a Defined Profile item to Yes or No (the default). This item controls whether or not the SDSL link will come up without an explicitly configured connection profile. If your ISP is serving you a dynamic IP Address, you need not explicitly configure a connection profile, and the default behavior of the router will be to connect automatically once it is powered on.

If Must Match a Defined Profile is set to No, then an IP Enabled item is visible. Toggling this item to Yes (the default) or No controls whether or not IP will be supported on the SDSL link. If IP Enabled is set to Yes, an IP Parameters item becomes visible. If you select IP Parameters the IP Parameters screen appears (see [“IP parameters \(default profile\) screen” on page 8-8](#)). This screen allows you to configure various IP parameters for SDSL connections established without an explicitly configured connection profile.

If Must Match a Defined Profile is set to No, then an IPX Enabled item is visible. Toggling this item to Yes or No (the default) controls whether or not IPX will be supported on the SDSL link. If IPX Enabled is set to Yes, an IPX Parameters item becomes visible. If you select IPX Parameters, the IPX Parameters screen appears (see [“IPX parameters \(default profile\) screen” on page 8-9](#)). This screen allows you to configure various IPX parameters for SDSL connections established without an explicitly configured connection profile.

## IP parameters (default profile) screen

If you are using RFC1483 datalink encapsulation, the IP Parameters (Default Profile) screen allows you to configure various IP parameters for SDSL connections established without an explicitly configured connection profile:

```

                                IP Parameters (Default Profile)

Address Translation Enabled:      No

Filter Set (Firewall)...
Remove Filter Set

Receive RIP:                      Both
Transmit RIP:                     Off

Return/Enter accepts * Tab toggles * ESC cancels.
```

For an SDSL link, Network Address Translation (NAT) is disabled by default in the Default Profile. You can enable it by toggling to Yes. For details on setting up IP Parameters see ["IP Setup and Network Address Translation"](#) on page 10-1.



## IPX parameters (default profile) screen

If you are using RFC1483 datalink encapsulation, the IPX Parameters (Default Profile) screen allows you to configure various IPX parameters for SDSL connections established without an explicitly configured connection profile:

```

                                IPX Parameters (Default Profile)

NetBios Packet Forwarding:      Off
Path Delay:                     10

Incoming Packet Filter Set...   <<NONE>>
Outgoing Packet Filter Set...   <<NONE>>
Incoming SAP Filter Set...      <<NONE>>
Outgoing SAP Filter Set...      <<NONE>>

Periodic RIP Timer:             60
Periodic SAP Timer:             60

```

For details on setting up IPX Parameters see ["IPX Setup" on page 11-1](#). For details on setting up Filter Sets see ["Security" on page 14-1](#).

---

## System configuration screens

You can connect to the Netopia R7200's system configuration screens in either of two ways:

- By using Telnet with the Router's Ethernet port IP address
- Through the console port, using a local terminal (see ["Connecting a console cable to your router" on page 6-3](#))

You can also retrieve the Netopia R7200's configuration information and remotely set its parameters using the Simple Network Management Protocol (see ["SNMP" on page 13-12](#)).

Open a Telnet connection to the router's IP address; for example, "192.168.1.1."

The console screen will open to the Main Menu, similar to the screen shown below:

```
Netopia R7200 v4.3.5

Easy Setup...
WAN Configuration...
System Configuration...
Utilities & Diagnostics...
Statistics & Logs...
Quick Menu...
Quick View...

Return/Enter goes to Easy Setup -- minimal configuration.
You always start from this main screen.
```

---

### *Navigating through the system configuration screens*

To help you find your way to particular screens, some sections in this guide begin with a graphical path guide similar to the following example:

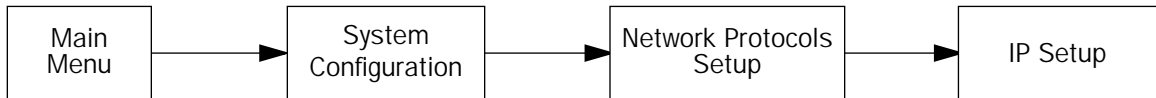

This particular path guide shows how to get to the Network Protocols Setup screens. The path guide represents these steps:

1. Beginning in the Main Menu, select **System Configuration** and press Return. The System Configuration screen appears.
2. Select **Network Protocols** and press Return. The Network Protocols screen appears.
3. Select **IP Setup** and press Return. The IP Setup screen appears.

To go back in this sequence of screens, use the Escape key.

## System configuration features

The Netopia R7200 SDSL Router's default settings may be all you need to configure your Netopia R7200. Some users, however, require advanced settings or prefer manual control over the default selections. For these users, the Netopia R7200 provides system configuration options.

To help you determine whether you need to use the system configuration options, review the following requirements. If you have one or more of these needs, use the system configuration options described in later chapters.

- System configuration of dynamic IP address distribution through DHCP, MacIP, or BootP
- Greater network security through the use of filters
- System configuration of AppleTalk LAN settings
- System configuration of connections to AppleTalk networks through the Internet or any IP network, using AURP (AppleTalk "tunneling")
- System configuration of connection profiles

To access the system configuration screens, select **System Configuration** in the Main Menu, then press Return.

The System Configuration menu screen appears:

```
System Configuration

Network Protocols Setup...
Filter Sets (Firewalls)...
IP Address Serving...

Date and Time...

Console Configuration...

SNMP (Simple Network Management Protocol)...

Security...

Upgrade Feature Set...

Logging...

Return/Enter to configure Networking Protocols (such as TCP/IP).
Use this screen if you want options beyond Easy Setup.
```

## *Network protocols setup*

These screens allow you to configure your network's use of the standard networking protocols:

- IP: Details are given in "IP Setup and Network Address Translation" on page 10-1.
- IPX: Details are given in "IPX Setup" on page 11-1.
- AppleTalk: Details are given in "AppleTalk Setup" on page 12-1.

**Note:** AppleTalk requires the optional AppleTalk feature expansion kit.

## *Filter sets (firewalls)*

These screens allow you to configure security on your network by means of filter sets and a basic firewall.

- Details are given in "Security" on page 14-1.

## *IP address serving*

These screens allow you to configure IP address serving on your network by means of DHCP, WANIP, BootP, and with the optional AppleTalk kit, MacIP.

- Details are given in "IP address serving" on page 10-21.

## *Date and time*

You can set the system's date and time in the Set Date and Time screen.

Select **Date and Time** in the System Configuration screen and press Return. The Set Date and Time screen appears.

Set Date and Time	
System Date Format:	MM/DD/YY
Current Date (MM/DD/YY):	3/16/1998
System Time Format:	AM/PM
Current Time:	10:29
AM or PM:	AM

Follow these steps to set the system's date and time:

1. Select **Current Date** and enter the date in the appropriate format. Use one- or two-digit numbers for the month and day, and the last two digits of the current year. The date's numbers must be separated by forward slashes (/).
2. Select **Current Time** and enter the time in the format HH:MM, where HH is the hour (using either the 12-hour or 24-hour clock) and MM is the minutes.
3. Select **AM or PM** and choose **AM** or **PM**.

## Console configuration

You can change the default terminal communications parameters to suit your requirements.

To go to the Console Configuration screen, select **Console Configuration** in the System Configuration screen.

Console Configuration

Baud Rate...	57600
Hardware Flow Control:	No

SET CONFIG NOW                      CANCEL

Follow these steps to change a parameter's value:

1. Select the parameter you want to change.
2. Select a new value for the parameter. Return to step 1 if you want to configure another parameter.
3. Select **SET CONFIG NOW** to save the new parameter settings. Select **CANCEL** to leave the parameters unchanged and exit the Console Configuration screen.

## SNMP (Simple Network Management Protocol)

These screens allow you to monitor and configure your network by means of a standard Simple Network Management Protocol (SNMP) agent.

- Details are given in "SNMP" on page 13-12.

## Security

These screens allow you to add users and define passwords on your network.

- Details are given in "Security" on page 14-1.

## Upgrade feature set

You can upgrade your Netopia R7200 by adding new feature sets through the Upgrade Feature Set utility.

See the release notes that came with your router or feature set upgrade, or visit the Netopia Web site at [www.netopia.com](http://www.netopia.com) for information on new feature sets, how to obtain them, and how to install them on your Netopia R7200.

## Logging

You can configure a UNIX-compatible syslog client to report a number of subsets of the events entered in the router's WAN Event History. See "WAN Event History" on page 13-6.

The Syslog client (for the PC only) is supplied as a .ZIP file on the Netopia CD.

Select **Logging** from the System Configuration menu.

The Logging Configuration screen appears.

```

                                Logging Configuration

WAN Event Log Options
Log Boot and Errors:           Yes
Log Line Specific:             Yes
Log Connections:               Yes
Log PPP, DHCP, CNA:           Yes
Log IP and IPX:                Yes

Syslog Parameters
Syslog Enabled:                 No
Hostname or IP Address:
Facility...                     Local 0

Return/Enter accepts * Tab toggles * ESC cancels.
```

By default, all events are logged in the event history.

- By toggling each event descriptor to either **Yes** or **No**, you can determine which ones are logged and which are ignored.
- You can enable or disable the syslog client dynamically. When enabled, it will report any appropriate and previously unreported events.
- You can specify the syslog server's address either in dotted decimal format or as a DNS name up to 63 characters.
- You can specify the UNIX syslog Facility to use by selecting the **Facility** pop-up.

## Installing the Syslog client

The Goodies folder on the Netopia CD contains a Syslog client daemon program that can be configured to report the WAN events you specified in the Logging Configuration screen.

To install the Syslog client daemon, exit from the graphical Netopia CD program and locate the CD directory structure through your Windows desktop or through Windows Explorer. Go to the Goodies directory on the CD and locate the Sds15000.exe program. This is the Syslog daemon installer. Run the Sds15000.exe program and follow the on-screen instructions for enabling the Windows Syslog daemon.

The following screen shows a sample syslog dump of WAN events:

```

May 5 10:14:06 tsnext.netopia.com Link 1 down: PPP PAP failure
May 5 10:14:06 tsnext.netopia.com >>Issued Speech Setup Request from our DN: 5108645534
May 5 10:14:06 tsnext.netopia.com Requested Disc. from DN: 917143652500
May 5 10:14:06 tsnext.netopia.com Received Clear Confirm for our DN: 5108645534
May 5 10:14:06 tsnext.netopia.com Link 1 down: Manual disconnect
May 5 10:14:06 tsnext.netopia.com >>Issued Speech Setup Request from our DN: 5108645534
May 5 10:14:06 tsnext.netopia.com Requested Disc. from DN: 917143652500
May 5 10:14:06 tsnext.netopia.com Received Clear Confirm for our DN: 5108645534
May 5 10:14:06 tsnext.netopia.com Link 1 down: No answer
May 5 10:14:06 tsnext.netopia.com --Device restarted-----
May 5 10:14:06 tsnext.netopia.com >>Received Speech Setup Ind. from DN: (not supplied)
May 5 10:14:06 tsnext.netopia.com Requested Connect to our DN: 5108645534
May 5 10:14:06 tsnext.netopia.com ASYNC: Modem carrier detected (more) Modem reports: 26400
V34
May 5 10:14:06 tsnext.netopia.com >>WAN: 56K Modem 1 activated at 115 Kbps
May 5 10:14:06 tsnext.netopia.com Connect Confirmed to our DN: 5108645534
May 5 10:14:06 tsnext.netopia.com PPP: Channel 1 up, Answer Profile name: Default Profile
May 5 10:14:06 tsnext.netopia.com PPP: NCP up, session 1, Channel 1 Final (fallback)
negotiated auth: Local PAP , Remote NONE
May 5 10:14:06 tsnext.netopia.com PPP: PAP we accepted remote, Channel 1 Remote name: guest
May 5 10:14:06 tsnext.netopia.com PPP: MP negotiated, session 1 Remote EDO: 06 03
0000C5700624 0
May 5 10:14:06 tsnext.netopia.com PPP: CCP negotiated, session 1, type: Ascend LZS Local
mode: 1, Remote mode: 1
May 5 10:14:06 tsnext.netopia.com PPP: BACP negotiated, session 1 Local MN: FFFFFFFF, Remote
MN: 00000001
May 5 10:14:06 tsnext.netopia.com PPP: IPCP negotiated, session 1, rem: 192.168.10.100 local:
192.168.1.1
May 5 10:14:06 tsnext.netopia.com >>WAN: 56K Modem 1 deactivated
May 5 10:14:06 tsnext.netopia.com Received Clear Ind. from DN: 5108645534, Cause: 0
May 5 10:14:06 tsnext.netopia.com Issued Clear Response to DN: 5108645534
May 5 10:14:06 tsnext.netopia.com Link 1 down: Remote clearing
May 5 10:14:06 tsnext.netopia.com PPP: IPCP down, session 1
May 5 10:14:06 tsnext.netopia.com >>Received Speech Setup Ind. from DN: (not supplied)

```





## Chapter 9

# Line Backup

The Netopia R7200 SDSL Router offers line backup functionality in the event of a line failure on your primary WAN link.

This chapter covers the following topics:

- “WAN Configuration” on page 9-2
- “IP Setup screen” on page 9-4
- “Connection Profiles” on page 9-5
- “Using Scheduled Connections with Backup” on page 9-5
- “Management/Statistics” on page 9-7
- “QuickView” on page 9-9
- “Event Logs” on page 9-9
- “SNMP Support” on page 9-9

The purpose of line backup is to provide a recovery mechanism in the event that the primary connection fails. A failure can be either line loss, for example by central site switch failure or physical cable breakage, or in the case of Frame Relay (with LMI) or PPP, loss of end-to-end connectivity. Detection of one of these failures causes the router to switch from using the primary WAN port to using the Auxiliary port to which a modem has been attached or to an internal asynchronous modem WAN module if one is installed. The port used for backup is determined by whether or not a second WAN module is installed in the router. If there is only one WAN module installed then the Auxiliary port is the backup port. If an asynchronous modem WAN module is installed in the second slot, then that is the backup port.

In the event of a loss of primary connectivity you have the option of switching back to the primary port automatically once it has recovered its connection.

The supported backup ports are the Auxiliary port or an asynchronous modem WAN module in Switched Asynchronous mode with PPP as the data link encapsulation.

---

## WAN Configuration

To configure Line Backup, from the Main Menu select **WAN Configuration** and then **Backup Configuration**.

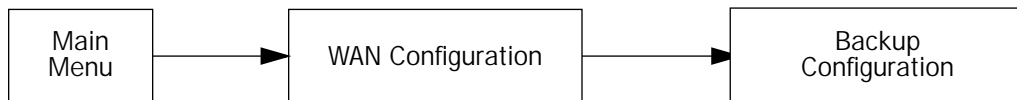

```

                                WAN Configuration

                                WAN (Wide Area Network) Setup...
                                Display/Change Connection Profile...
                                Add Connection Profile...
                                Delete Connection Profile...

                                WAN Default Answer Profile...

                                Scheduled Connections...

                                Backup Configuration...

                                Establish WAN Connection...
                                Disconnect WAN Connection...

                                From here you will configure yours and the remote sites' WAN information.
```

The Backup Configuration screen appears.

## Backup Configuration screen

This screen is used to configure the conditions under which backup will occur, if it will recover, and how the auxiliary port is configured. The circuit type is Switched Asynchronous.

Backup Configuration	
Backup Parameters:	
Backup to Auxiliary Port...	Automatic
Requires Data Link Failure of...	30 Sec
Ping Host Name or IP Address:	
Recovery to DLC SDSL...	Manual
Auxiliary Port Setup:	
Data Rate (kbps)...	57.6
Modem Initialization String:	AT&F&C1&D2E0S0=1
Modem Dialing Prefix:	ATDT
Data Link Encapsulation is	Async PPP
Enter Information supplied to you by your telephone company.	

- Select **Backup to Auxiliary Port** or **Backup to Internal Modem** and press Return. The system automatically senses whether you have an internal modem card installed in the second slot. If you do not, this menu item will be Auxiliary Port; if you do, this item will be Internal Modem. A pop-up menu allows you to select Disabled, Manual, or Automatic. You enable line backup by selecting either Manual or Automatic. If you enable backup, the subsequent menu items become visible.
- Select **Requires Data Link Failure of...** and press Return. A pop-up menu allows you to choose among 30s(econds), 1m(inute), 2m, 5m, 10m, or 15m to determine how long you want the system to wait before the backup port becomes enabled in the event of primary line failure. This allows you to be sure that the primary WAN connection is not merely briefly interrupted before the router switches to backup mode.
- Select **Ping Host Name or IP Address** and enter an IP address or resolvable DNS name that the router will ping. Should this address become unreachable the router will treat this as a loss of connectivity and begin the backup timer.
- Select **Recovery to "WAN\_name"** (where *WAN\_name* is the type of WAN connection you have, e.g., SDSL) and press Return. Choose either **Manual** or **Automatic** to determine how the system will return to the primary WAN link when it becomes available again. If you choose Automatic, the next two menu items become visible.

**Note:** Automatic recovery only works upon loss of primary WAN connectivity.

- If you chose Automatic Recovery, select **Requires Recovery of...** and press Return. A pop-up menu allows you to choose among 30s(econds), 1m(inute), 2m, 5m, 10m, or 15m. This allows you to be sure that the primary WAN connection is well re-established before the router switches back to it from the backup mode.
- You can toggle **Recovery on loss of Layer 2** to Yes or No (the default). This setting determines whether

the router should try to Auto-Recover when the backup is invoked because of a Layer 2 loss. (Layer 1 is still available, and this is what recovery checks.) Use this setting with caution. Setting it to Yes may induce alternate switching back and forth between Backup and Recovery Mode. This setting also determines the recovery behavior of a Manual backup and Ping failure backup. These two failures are treated as Layer 2 failures.

- Select **Data Rate (kbps)**... and choose your modem speed (19.2, 38.4, 57.6, 115.2, or 230.4) from the pop-up menu.
- The default **Modem Initialization String** is AT&F&C1&D2E0S0=1. You can edit it if you need to. Refer to your modem's documentation.
- The default **Modem Dialing Prefix** is ATDT. You can edit it if you need to. Refer to your modem's documentation.
- Data Link Encapsulation is set to Async PPP. This field is not editable.

**Note:** Auxiliary port configuration in the Line Configuration Screen for the WAN module is hidden if backup is enabled and no Internal modem WAN module is installed.

---

## IP Setup screen

The IP Setup screen now permits entry of a backup IP gateway address. This field is visible if the Default IP Gateway field is filled out and Backup is enabled. You must have a default gateway configured for the backup gateway item to become visible. If you delete the default gateway the backup gateway entry moves into its place.

IP Setup

Ethernet IP Address:	3.3.3.3
Ethernet Subnet Mask:	255.0.0.0
Define Additional Subnets...	
Default IP Gateway:	1.1.1.3
Backup IP Gateway:	x.x.x.x
Primary Domain Name Server:	0.0.0.0
Domain Name:	
Receive RIP:	Both
Transmit RIP:	Off
Static Routes...	
IP Address Serving Setup	
Network Address Translation (NAT)...	
Filter Sets...	

Enter an IP address in decimal and dot form (xxx.xxx.xxx.xxx).  
Set up the basic IP attributes of your Netopia in this screen.

For more information on IP Setup see ["IP Setup and Network Address Translation"](#) on page 10-1.

## Connection Profiles

The line backup feature allows you to configure a complete connection profile for the backup port, just as you do for your primary WAN connection. In this way profiles are associated with a particular interface. The profile should reflect the port it is associated with. It should have switched characteristics for the backup port.

```

                                Add Connection Profile

Profile Name:                    Backup
Profile Enabled:                 Yes

Data Link Encapsulation is      PPP
Data Link Options...

IP Enabled:                      Yes
IP Profile Parameters...

IPX Enabled:                     No

Interface Group...              Backup
Telco Options...

ADD PROFILE NOW                  CANCEL

Return/Enter to discard changes you have made. Profile will not be added.
Configure a new Conn. Profile. Finished? ADD or CANCEL to exit.

```

For instructions on creating a connection profile see [“Creating a new Connection Profile”](#) on page 8-3.

To associate this connection profile with your backup port interface, choose **Backup** from the Interface Group pop-up menu and press Return.

## Using Scheduled Connections with Backup

The backup link is a PPP dial-up connection and only connects to the Internet service provider when traffic is initiated from the LAN. If you want to use the backup link to provide redundancy for services, such as a web service that you provide to the outside world, you must force the connection to stay up. You do this by creating a scheduled connection entry that will be a permanent “forced up” connection for the backup port. The backup port will be activated upon primary WAN link failure and remain active until primary WAN link recovery.

To configure a Scheduled Connection, from the Main Menu select **WAN Configuration** and then **Scheduled Connections**.

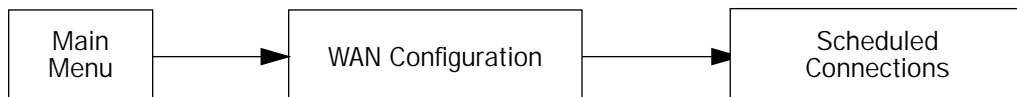

The Scheduled Connections screen appears.

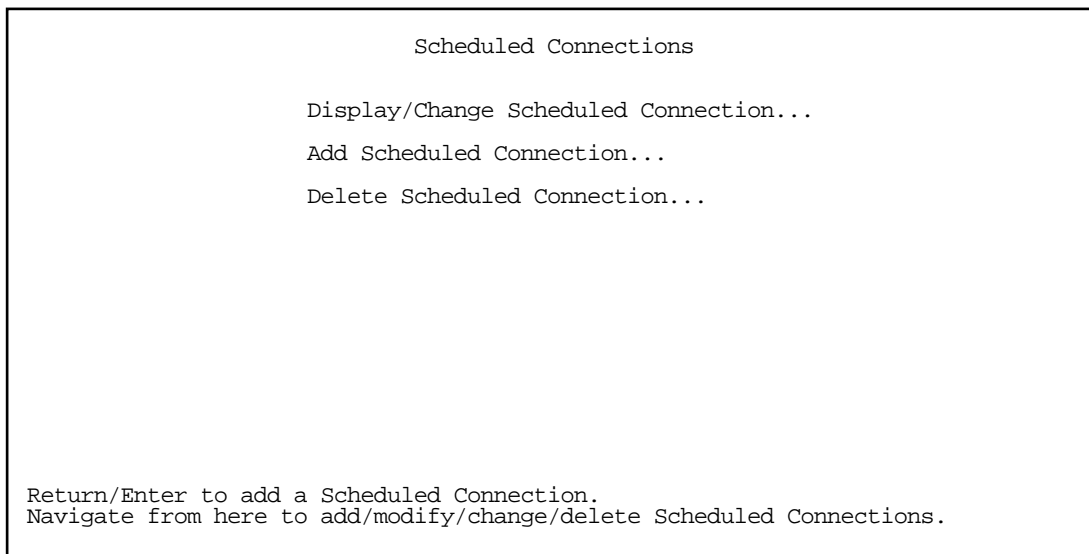

- Select **Add Scheduled Connection** and press Return. The Add Scheduled Connection screen appears.

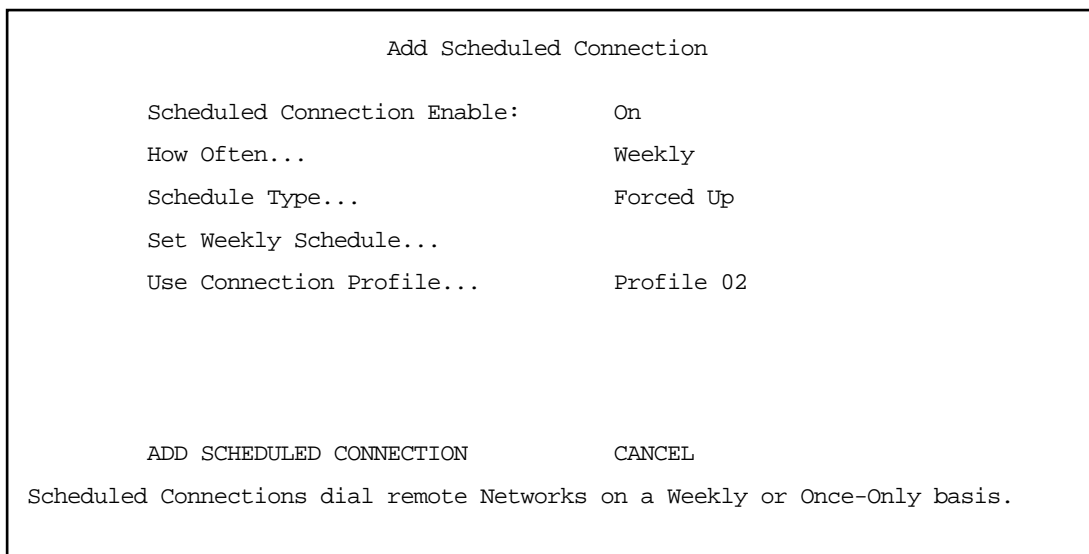

- Toggle **Scheduled Connection Enable** to **On**.
- From the **How Often** pop-up menu, select **Weekly** and press Return.
- From the **Schedule Type** pop-up menu, accept the default **Forced Up** and press Return.
- Select **Set Weekly Schedule** and press Return. The Set Weekly Schedule screen appears.

```

                                Set Weekly Schedule

Monday:                          Yes
Tuesday:                         Yes
Wednesday:                       Yes
Thursday:                        Yes
Friday:                          Yes
Saturday:                        Yes
Sunday:                          Yes

Scheduled Window Start Time:     11:27
AM or PM:                        AM

Scheduled Window Duration Per Day: 24:00

Return/Enter accepts * Tab toggles * ESC cancels.

```

- Toggle all the days of the week to **Yes**, and set the **Scheduled Window Duration Per Day** to **24:00**. This guarantees a permanent connection. Press Escape to return to the Add Scheduled Connection screen.
- Select **Use Connection Profile** and press Return. A screen displays all of your connection profiles. Select the one you want to apply this scheduled connection to and press Return. Your selection becomes effective.

Now, if your primary WAN link fails, the backup link will become active and remain active until the primary link recovers.

---

## Management/Statistics

The Statistics & Logs menu offers a Backup Management/Statistics option.

To view the Backup Management/Statistics, from the Main Menu select **Statistics & Logs**.



```
Statistics & Logs

WAN Event History...
Device Event History...

IP Routing Table...

IPX Routing Table...
IPX SAP Bindery Table...

Served IP Addresses...
Backup Management/Statistics...

General Statistics...
System Information...
```

Select **Backup Management/Statistics** and press Return.

**Note:** This option is only visible if backup is not Disabled.

The Backup Management/Statistics screen appears.

```
Backup Management/Statistics

Current Port:                Auxiliary Port
Backup State:                Backup Mode
Time Since Detection:        15

FORCE RECOVERY
```

- **Current Port** is a display-only field that shows which port is currently in operation.
- **Backup State** is a display-only field that shows the current state of Backup or Recovery.
- **Time Since Detection** is a display-only field that is only visible if backup or recovery is in progress. It displays the elapsed time since detection of either primary WAN line failure or re-establishment of the



connection.

- The **FORCE BACKUP/FORCE RECOVERY** option is a selectable option that depending on the current state of backup will force the switching of ports. If you are currently in backup mode, the option will be **FORCE RECOVERY**. If you are currently in normal WAN link mode, the option will be **FORCE BACKUP**. Selecting either one and pressing Return will force the link to switch to the other mode.

---

## QuickView

QuickView now has an information element to indicate which port is in use.

```

                                Quick View
Default IP Gateway: 0.0.0.0
Domain Name Server: 0.0.0.0
Domain Name: happyinternet.com
                                CPU Load: 4%   Unused Memory: 387 KB
                                WAN Interface Group -- Auxiliary Port
  
```

---

## Event Logs

When a backup or recovery occurs an event is logged in the WAN Event History.

```

                                WAN Event History
                                Current Date -- 4/17/99 10:57:12 AM
-Date-----Time-----Event-----
-----SCROLL UP-----
04/17/99 10:39:37 * Line Failure: Switching to backup port
04/17/99 10:38:51 * Line Recovery: Switching to primary port
04/17/99 10:37:42 * Line Failure: Switching to backup port
04/17/99 10:35:53 --Device restarted-----
04/17/99 10:04:48 --Device restarted-----
04/17/99 10:04:13 --Device restarted-----
04/17/99 08:59:01 --Device restarted-----
04/14/99 09:12:09 --Device restarted-----
04/13/99 10:31:08 --Device restarted-----
04/13/99 09:47:57 >>WAN: SDSL 1 deactivated
04/13/99 09:47:56 >>WAN: SDSL 1 activated at 10000 Kbps
04/13/99 09:42:07 --Device restarted-----
04/13/99 09:29:45 --Device restarted-----
04/12/99 11:29:44 --Device restarted-----
-----SCROLL DOWN-----
Clear History...

Return/Enter on event item for details or SCROLL [UP/DOWN] item for scrolling.
  
```

---

## SNMP Support

The router supports objects for determining the state of backup, as well as providing traps for the backup and recovery events. No objects support configuration of backup or recovery.



## Chapter 10

# IP Setup and Network Address Translation

The Netopia R7200 uses Internet Protocol (IP) to communicate both locally and with remote networks. This chapter shows you how to configure the router to route IP traffic. You also learn how to configure the router to serve IP addresses to hosts on your local network.

Netopia's SmartIP features Network Address Translation and IP address serving.

This section covers the following topics:

- "Network Address Translation features" on page 10-1
- "Using Network Address Translation" on page 10-3
- "Connection Profiles" on page 10-8
- "IP setup" on page 10-11
- "IP address serving" on page 10-21

Network Address Translation allows communication between the LAN connected to the Netopia R7200 and the Internet using a single IP address instead of a routed account with separate IP addresses for each computer on the network.

Network Address Translation also provides increased security by hiding the local IP addresses of the LAN connected to the Netopia R7200 from the outside world.

With SmartIP, the setup is simpler, so Internet service providers typically offer internet accounts supporting Network Address Translation at a significant cost savings.

For a detailed discussion of Network Address Translation, see [Appendix C, "Understanding Netopia NAT Behavior."](#)

---

## Network Address Translation features

Network Address Translation (NAT) offers users the following features:

- NAT is selectable on a per connection basis, optionally allowing real addresses to be used for intranet connections and proxied addresses to be used for Internet connections.
- You can use any combination of proxied and unproxied addresses simultaneously on the available telco channels. For instance, one unproxied address connection profile can be used to connect to a central office, while another proxied address connection profile can simultaneously connect the user's Netopia R7200 and LAN to the Internet.
- The single proxy address is acquired at connection time from the answering side. The address can be assigned by the remote router from either a dynamic pool of addresses or a fixed, static address.
- Static NAT security is simpler and more reliable because only one IP address needs a firewall, and because the internal network structure is not visible from the Internet.

NAT works by remapping the source IP address of traffic from the LAN to a single static or dynamically assigned IP address shown to the remote side of the router.

### HOW NAT WORKS

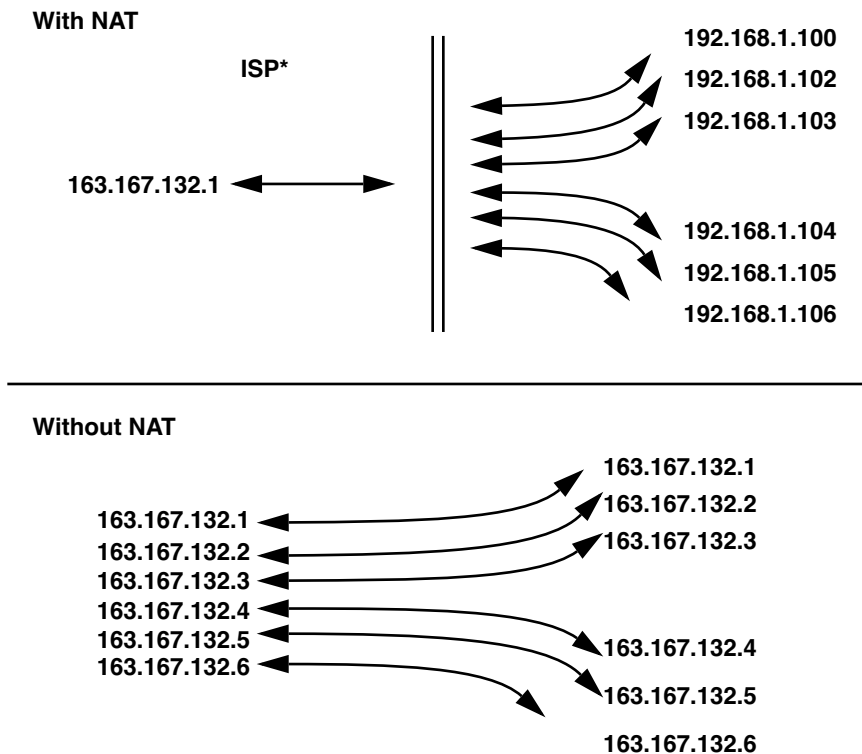

**\*or corporate intranet router**

The feature can be implemented on a per-connection profile basis. The network router can use two or more connection profiles simultaneously to connect to two or more networks. Each profile can have NAT enabled.

When NAT is enabled, the Netopia R7200 can use either a statically assigned IP address or one dynamically assigned each time the router connects to the ISP. While a dynamically assigned IP address offers the ISP more flexibility, it does have an important limitation: the router requires a static IP address to support Web, FTP, or other services available to the WAN. To support these services with NAT enabled, a service can be associated with only one machine on the LAN.

When connected to the Internet or some other large network using NAT, the individual machines on your LAN are not directly accessible from the WAN. NAT provides an inherently secure method of connection to the outside world.

## Using Network Address Translation

The following procedure describes how to use Network Address Translation.

1. Pick a network number for your local network (referred to as the internal network). This can be any IP address range you want. The Netopia R7200 SDSL Router has a default IP address of 192.168.1.1. You may choose to change this address to match a pre-existing addressing scheme. For this example, we will use 10.0.0.0.

**Note:** The outside world (the external network) will not see this network number.

2. Using the internal network number, assign addresses to the local nodes on your LAN. For example, you could assign
  - 10.0.0.1 to your Netopia R7200
  - 10.0.0.2 to a node running as a World Wide Web server
  - 10.0.0.3 to an FTP server
  - 10.0.0.4 to a Windows NT PC
  - 10.0.0.5 to a Windows 95 PC

**Note:** See “Associating port numbers with nodes” on page 10-6.

3. In the connection profile, toggle **Address Translation Enabled** to **Yes** or **No** (Yes to enable NAT) and press Return.

The Easy Setup connection profile is accessible by using either of the following two approaches:

- From the Easy Setup menu in the Main Menu screen, select the next screen, **Connection Profile 1: Easy Setup Profile**. The screen shown below appears.

Connection Profile 1: Easy Setup Profile

Address Translation Enabled:	Yes
IP Addressing...	Numbered
Local WAN IP Address:	163.176.107.2
Local WAN IP Mask:	255.255.255.0

PREVIOUS SCREEN
NEXT SCREEN

Toggle to Yes if this is a single IP address ISP account.  
 Enter basic information about your WAN connection with this screen.

- Alternatively, from the WAN Configuration menu in the Main Menu screen, select **Display/Change Connection Profile**. When that screen appears, select **IP Profile Parameters**. You can now access the

Address Translation option from the IP Profile Parameters menu.

IP Profile Parameters	
Address Translation Enabled:	Yes
IP Addressing...	Unnumbered
Local WAN IP Address:	0.0.0.0
Remote IP Address:	0.0.0.0
Remote IP Mask:	0.0.0.0
Filter Set...	
Remove Filter Set	
Receive RIP:	Both
Transmit RIP:	v2 (multicast)

Configure IP requirements for a remote network connection here.

4. Select **IP Addressing** and, from the pop-up menu, choose the IP routing method that your ISP or network administrator specifies (either Numbered or Unnumbered). For more information see [Appendix B, "Understanding IP Addressing,"](#) and [Appendix C, "Understanding Netopia NAT Behavior."](#)

5. If your ISP uses numbered (interface-based) routing, select **Local WAN IP Address** and enter the local WAN address your ISP gave you. Then select **Local WAN IP Mask** and enter the WAN subnet mask of the remote site you will connect to.

The default address is 0.0.0.0, which allows for dynamic addressing, meaning that your ISP assigns an address via DHCP each time you connect. However, if you want to use static addressing, enter a specific address.

IP Profile Parameters	
Address Translation Enabled:	Yes
IP Addressing...	Numbered
Local WAN IP Address:	0.0.0.0
Local WAN IP Mask:	0.0.0.0
Filter Set...	
Remove Filter Set	
Receive RIP:	Off

Enter an IP address in decimal and dot form (xxx.xxx.xxx.xxx).  
Configure IP requirements for a remote network connection here.

**Note:** The Local WAN IP Address is displayed for numbered and/or NAT profiles. The Local WAN IP Mask is displayed for numbered profiles. The Remote IP Address and Remote IP Mask are displayed for unnumbered profiles.

IP Profile Parameters	
Address Translation Enabled:	Yes
IP Addressing...	Unnumbered
Remote IP Address:	0.0.0.0
Remote IP Mask:	0.0.0.0
Filter Set...	
Remove Filter Set	
Receive RIP:	Off
Transmit RIP:	Off

Return/Enter to select <among/between> ...  
Configure IP requirements for a remote network connection here.

## 10-6 User's Reference Guide

When using numbered interfaces, the Netopia Router will use its local WAN IP address and subnet mask to send packets to the remote router. Both routers have WAN IP addresses and subnet masks associated with the connection.

6. If your ISP uses unnumbered (system-based) routing, select **Remote IP Address** and enter the IP address your ISP gave you. Then select **Remote IP Mask** and enter the IP subnet mask of the remote site you will connect to.

**Note:** When using unnumbered interfaces, the Netopia Router will use either its local Ethernet IP address or its NAT (Network Address Translation) address (if so configured) and subnet mask to send packets to the remote router. Neither router has a WAN IP address or subnet mask associated with this connection. These default addresses will request that the remote router dynamically assign an address at the time the connection is made.

7. When your Netopia R7200 connects to the ISP, the remote router assigns your Netopia R7200 an IP address that external users use to communicate with your network.

The following Quick View screen shows an example in which 192.168.100.6 is assigned to the Netopia R7200. "NAT" indicates that the address was assigned dynamically by Network Address Translation.

```
Quick View                                12/11/1998 12:45:44 PM
Default IP Gateway: 0.0.0.0                CPU Load: 2%      Unused Memory: 952 KB
Domain Name Server: 0.0.0.0                LocalTalk Address: 34448:149
Domain Name: None Provided

-----MAC Address-----IP Address-----IPX Address---EtherTalk---
Ethernet Hub: 00-00-c5-70-03-48 192.168.1.1          34449:150
SDSL WAN1: 00-00-c5-70-03-4a 0.0.0.0

Current DSL Status
Profile Name-----Rate--%Use-Remote Address-----Est.-More Info-----
ISP                P1    10% IP 92.163.4.1    Lcl NAT 192.168.100.6

LED Status
PWR+-----WAN1-----+---CON---AUX---+-----WAN2-----+---EN---+-----LEDS-----
LNK RDY CH1 CH2   LNK  LNK   LNK RDY CH1 CH2  DATA | '-'= Off 'G'= Green
```

Internal users can access the Internet as they always do; the external Internet, however, views all traffic from the internal network as originating from 192.168.100.6 and all traffic your network receives is addressed to 192.168.100.6.

## Associating port numbers with nodes

When an IP client such as a Netscape Navigator or Microsoft Internet Explorer wants to establish a session with an IP server such as a Web server, the client machine must know the IP address to use and the TCP service port where the traffic is to be directed.

For example, a Web browser locates a Web server by using a combination of the IP address and TCP port that the client machine has set up.



Just as an IP address specifies a particular computer on a network, ports are addresses that specify a particular service in a computer. There are many universally agreed-upon ports assigned to various services. For example:

- Web servers typically use port number 80
- All FTP servers use port number 21
- Telnet uses port number 23
- SNMP uses port number 161

To help direct incoming IP traffic to the appropriate server, the Netopia R7200 lets you associate these and other port numbers with distinct IP addresses on your internal LAN using exported services. See [“IP setup” on page 10-11](#) for details.

---

### *Advanced IP/IPX router configuration options*

Advanced users can optionally use connection profiles to configure the IP and IPX protocol stack interfaces on the SDSL link. You need not explicitly define these parameters, however. The following information is provided as reference to the possible router configurations advanced users may desire.

The IP router interface on the SDSL link:

- may be numbered or unnumbered.
- may or may not use Network Address Translation (NAT).
- will attempt to autoconfigure itself without an explicitly configured connection profile, if permitted to do so by the setting of the Must Match a Defined Profile item in the Default Profile screen. See [“The default profile” on page 8-6](#).

The link up process at the interface between the SDSL data link encapsulation module and the IP router functions as follows:

- When the SDSL data link comes up, the router will search for a configured connection profile that specifies SDSL encapsulation.
- If more than one SDSL profile exists, the router will use the first such profile.
- If no SDSL profile exists, and the Must Match a Defined Profile field in the Default SDSL Profile is set to No, the router will construct a Default Profile, and the link up process will continue using this constructed profile as if it were an explicitly configured one.
- If no SDSL profile exists, and the Must Match a Defined Profile field in the Default SDSL Profile is set to Yes, IP will not come up on the SDSL link. The router will log an “IP connection refused” event in the WAN Event History.
- If an SDSL profile exists (or a default one has been constructed), the router will attempt to configure its interface on the SDSL link using the information stored in the profile.

## Connection Profiles

Since you will probably only have a single connection to your ISP over the SDSL link, you may not need to create multiple connection profiles. Multiple connection profiles are useful on leased (unswitched) interfaces such as SDSL only to support meshed WAN connections. If you do not intend to set up meshed WAN connections, you do not need to create multiple connection profiles.

Connection profiles may be used to define the connection information for your WAN Auxiliary Port access.

Connection Profiles define the line and networking protocols necessary for the router to make a remote connection. A connection profile is like an address book entry describing how the router is to get to a remote site, or how to recognize and authenticate a remote user dialing in to the router. For example, to create a new Connection Profile, you navigate to the WAN Configuration screen from the Main Menu, and select **Add Connection Profile**.

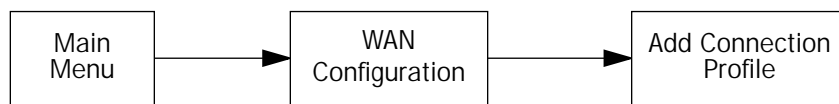

The Add Connection Profile screen appears.

```

                                Add Connection Profile

Profile Name:                    Profile 01
Profile Enabled:                 Yes
IP Enabled:                      Yes
IP Profile Parameters...
IPX Enabled:                     No
Data Link Encapsulation...      PPP
Data Link Options...

ADD PROFILE NOW                  CANCEL

Return accepts * ESC cancels * Left/Right moves insertion point * Del deletes.
Configure a new Conn. Profile. Finished? ADD or CANCEL to exit.
  
```

On a Netopia R7200 SDSL Router you can add up to 15 more connection profiles, for a total of 16, although only one can be used at a time.

1. Select **Profile Name** and enter a name for this connection profile. It can be any name you wish. For example: the name of your ISP.
2. Toggle the **Profile Enabled** value to Yes or No. The default is Yes.
3. Select **IP Profile Parameters** and press Return. The IP Profile Parameters screen appears.

```

                                IP Profile Parameters

Address Translation Enabled:      Yes

IP Addressing...                 Unnumbered
Local WAN IP Address:           0.0.0.0
Local WAN IP Mask:              0.0.0.0
Remote IP Address:              0.0.0.0
Remote IP Mask:                 0.0.0.0

Filter Set...
Remove Filter Set

Receive RIP:                     Both
Transmit RIP:                   v2 (multicast)

Configure IP requirements for a remote network connection here.

```

4. Toggle or enter any IP parameters you require and return to the Add Connection Profile screen by pressing Escape. For more information on NAT, see ["Using Network Address Translation," beginning on page 10-3.](#) For more information on IP addressing, see [Appendix B, "Understanding IP Addressing."](#)

The Local WAN IP Address is displayed for numbered or NAT profiles. The Local WAN IP Mask is displayed for numbered profiles. The Remote IP Address and Remote IP Mask are displayed for unnumbered profiles.

5. If you will be connecting with an IPX remote network, toggle **IPX Enabled** to Yes, and press Return. Otherwise, accept the default No.

If you enable IPX routing, an **IPX Profile Parameters** menu item becomes available. Select **IPX Profile Parameters** and press Return. The IPX Profile Parameters screen appears.

```

                                IPX Profile Parameters

Remote IPX Network:              00000000
Path Delay:                     10
NetBios Packet Forwarding:      Off

Incoming Packet Filter Set...    <<NONE>>
Outgoing Packet Filter Set...    <<NONE>>

Incoming SAP Filter Set...       <<NONE>>
Outgoing SAP Filter Set...       <<NONE>>

Periodic RIP Timer:             60
Periodic SAP Timer:             60

Configure IPX requirements for a remote network connection here.

```

6. Toggle or enter any IPX parameters you require and return to the Add Connection Profile screen by pressing Escape. For more information, see ["IPX Setup" on page 11-1.](#)

7. Select **ADD PROFILE NOW** and press Return. Your new connection profile will be added.

If you want to view the connection profiles in your router, return to the WAN Configuration screen, and select **Display/Change Connection Profile**. The list of connection profiles is displayed in a scrolling pop-up screen.

```

                                WAN Configuration
+--Profile Name-----IP Address----IPX Network--+
| Easy Setup Profile          127.0.0.2
| Profile 02                  0.0.0.0
+-----+-----+-----+-----+-----+-----+

```

Up/Down Arrow Keys to select, ESC to dismiss, Return/Enter to Edit.

## Network Address Translation guidelines

Observe the following guidelines when using Network Address Translation.

- The router can export only one local IP address per UDP/TCP port, so you can have just one machine available for a given service, such as one FTP server. However, some services, such as Web servers (www-http servers), allow you to change the UDP/TCP port on both the server and client. With two different UDP/TCP ports exported, you can have Web servers on two different IP hosts.
- If you will be using multiple connection profiles, define the remote IP address of the most accessible profile, such as that for your ISP, to the default IP gateway in the TCP/IP settings on users' workstations. That way, IP traffic not intended specifically for any of the remote networks will be routed through this "preferred" profile.
- Associate your primary Domain Name Server (DNS) with whichever profile is more accessible. If you choose for neither profile to be "dial-on-demand," you can associate a secondary DNS with the other profile. See "IP setup," below, for more information on these settings.

## IP setup



The IP Setup options screen is where you configure the Ethernet side of the Netopia R7200. The information you enter here controls how the router routes IP traffic.

Consult your network administrator or Internet service provider to obtain the IP setup information (such as the Ethernet IP address, Ethernet subnet mask, default IP gateway and Primary Domain Name Server IP address) you will need before changing any of the settings in this screen. Changes made in this screen will take effect only after the Netopia R7200 is reset.

To go to the IP Setup options screen, from the Main Menu, select **System Configuration**, then **Network Protocols Setup**, and then **IP Setup**.

The IP Setup screen appears.

IP Setup

```

Ethernet IP Address:          192.128.117.162
Ethernet Subnet Mask:       255.255.255.0
Define Additional Subnets...

Default IP Gateway:         192.128.117.163

Primary Domain Name Server:  0.0.0.0
Secondary Domain Name Server: 0.0.0.0
Domain Name:

Receive RIP:                Both
Transmit RIP:                v2 (multicast)
Static Routes...

Address Serving Setup...
Exported Services...
Filter Sets...
  
```

Follow these steps to configure IP setup for your Netopia R7200:

- Select **Ethernet IP Address** and enter the IP address for the Netopia R7200's Ethernet port.
- Select **Ethernet Subnet Mask** and enter the subnet mask for the Ethernet IP address that you entered in the last step.
- For unlimited-user models, if you desire multiple subnets select **Define Additional Subnets**. twelve-user models do not offer this option. If you select this item you will be taken to the IP Subnets screen. This screen allows you to define IP addresses and masks for additional subnets. See ["IP subnets" on page 10-15](#) for details.

The Netopia R7200 SDSL Router supports multiple IP subnets on the Ethernet interface. You may want to configure multiple IP subnets to service more hosts than are possible with your primary subnet. It is not always possible to obtain a larger subnet from your ISP. For example, if you already have a full Class C subnet, your only option is multiple Class C subnets, since it is virtually impossible to justify a Class A or Class B assignment. This assumes that you are not using NAT.

If you are using NAT, you can use the reserved Class A or Class B subnet.

- Select **Default IP Gateway** and enter the IP address for a default gateway. This can be the address of any major router accessible to the Netopia R7200.

A default gateway should be able to successfully route packets when the Netopia R7200 cannot recognize the intended recipient's IP address. A typical example of a default gateway is the ISP's router.

- Select **Primary Domain Name Server** and enter the IP address for a domain name server. The domain name server matches the alphabetic addresses favored by people (for example, robin.hood.com) to the IP addresses actually used by IP routers (for example, 163.7.8.202).
- If a secondary DNS server is available, select **Secondary Domain Name Server** and enter its IP address. The secondary DNS server is used by the Netopia R7200 when the primary DNS server is inaccessible. Entering a secondary DNS is useful but not necessary.
- Select **Domain Name** and enter your network's domain name (for example, netopia.com). Netopia strongly recommends that you enter a domain name.
- Routing Information Protocol (RIP) is needed if there are IP routers on other segments of your Ethernet network that the Netopia R7200 needs to recognize. If this is the case select **Receive RIP** and select **v1**, **v2**, or **Both** from the pop-up menu. With Receive RIP set to v1, the Netopia R7200's Ethernet port will accept routing information provided by RIP packets from other routers that use the same subnet mask. Set to v2, the Netopia R7200 will accept routing information provided by RIP packets from other routers that use different subnet masks. Set to Both, the Netopia R7200 will accept information from either RIP v1 or v2 routers.
- If you want the Netopia R7200 to advertise its routing table to other routers via RIP, select **Transmit RIP** and select **v1**, **v2 (broadcast)**, or **v2 (multicast)** from the pop-up menu. With Transmit RIP v1 selected, the Netopia R7200 will generate RIP packets only to other RIP v1 routers. With Transmit RIP v2 (broadcast) selected, the Netopia R7200 will generate RIP packets to all other hosts on the network. With Transmit RIP v2 (multicast) selected, the Netopia R7200 will generate RIP packets only to other routers capable of recognizing RIP v2 packets.
- Select **Static Routes** to manually configure IP routes. See the section "[Static routes](#)," below.
- If you select **Address Serving Setup** you will be taken to the IP Address Serving screen (see "[IP address serving](#)" on page 10-21.) Since no two hosts can use the same IP address at the same time, make sure that the addresses distributed by the Netopia R7200, and those that are manually configured are not the same. Each method of distribution must have its own exclusive range of addresses to draw from.
- Select **Exported Services**. The Exported Services screen appears with three options: Show/Change Exports, Add Export, and Delete Export.

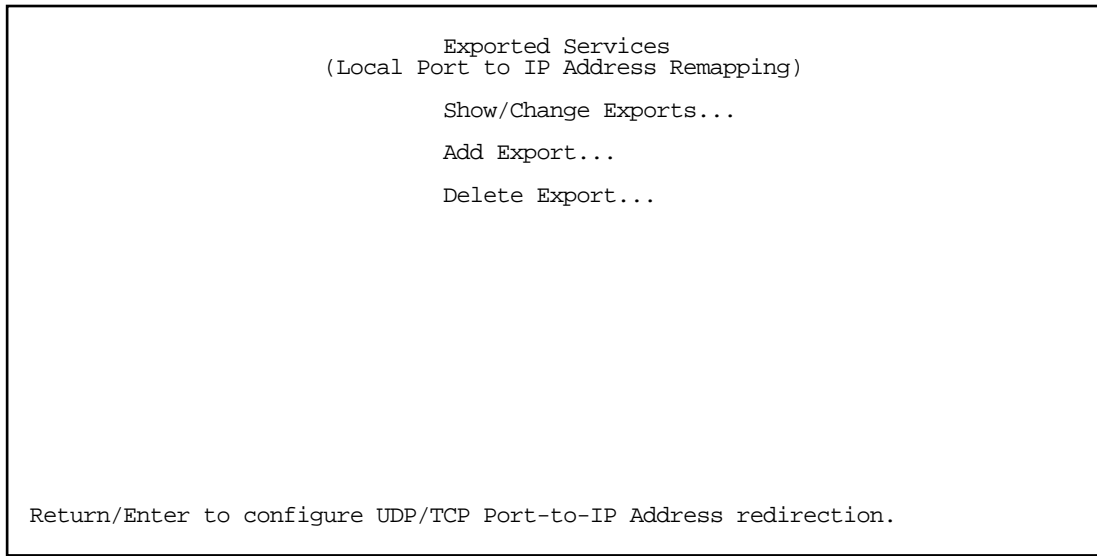

- Select **Add Export**. The Add Exported Service screen appears.

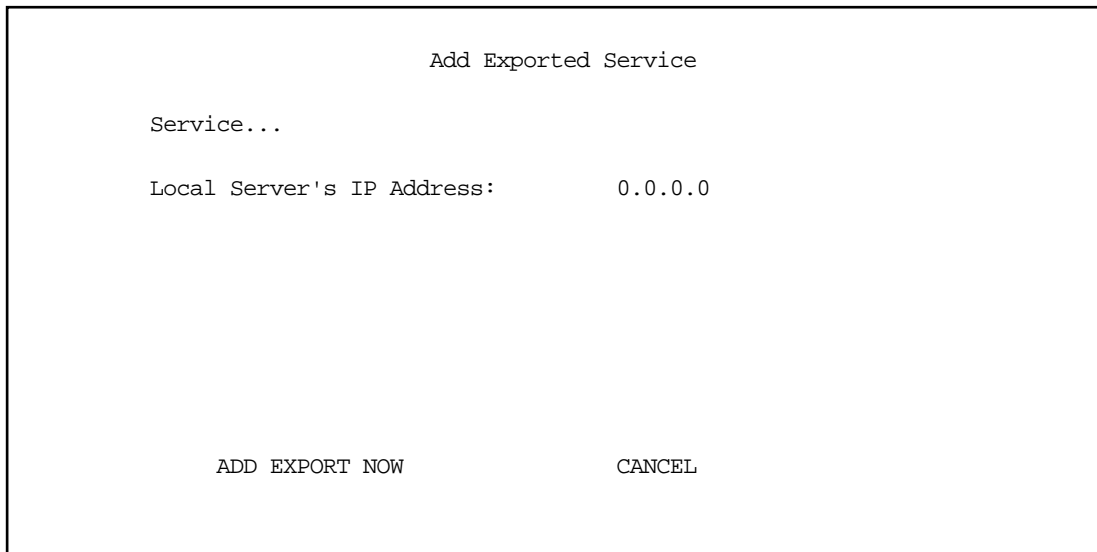

- Select **Service**. A pop-up menu of services and ports appears.

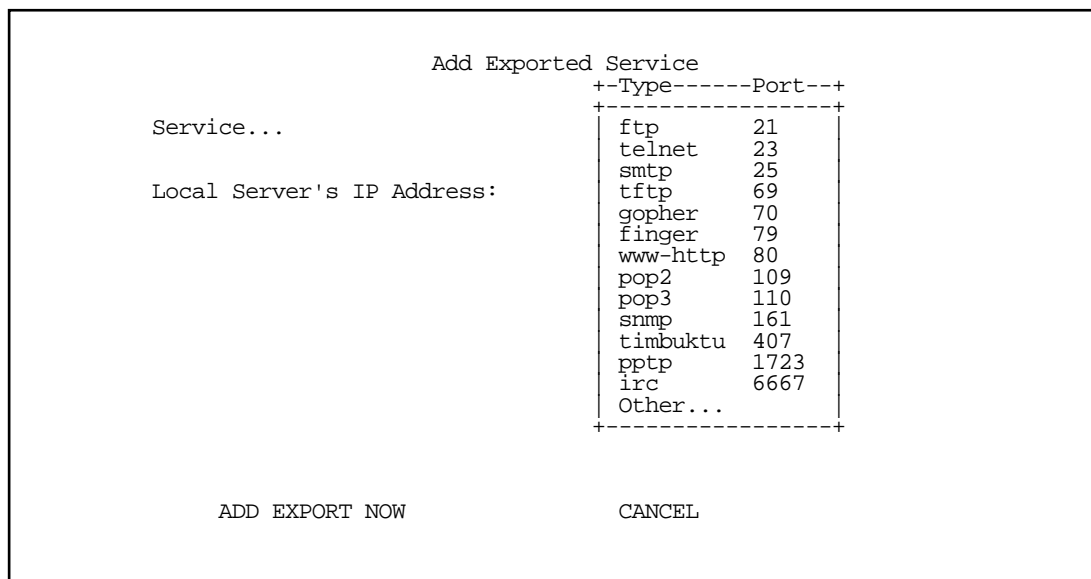

8. Select any of the services/ports and press Return to associate it with the address of a server on your local area network. For example, if you select **www-http 80**, press Return, and type **10.0.0.2**, the Netopia R7200 redirects any incoming traffic destined for a Web server to address 10.0.0.2.

Some services such as Timbuktu require the export of multiple TCP ports. When you associate Timbuktu with a local server (or Timbuktu host) all of the major Timbuktu services are exported, i.e., Observe, Control, Send, and Exchange.

**Note:** If the TCP port of a service you want to use is not listed, you can add it by selecting **Other...** on the pop-up menu.



Press Escape when you are finished configuring exported services. You are returned to the IP Setup screen.

```

                                IP Setup

Ethernet IP Address:             192.128.117.162
Ethernet Subnet Mask:          255.255.255.0
Define Additional Subnets...

Default IP Gateway:            192.128.117.163

Primary Domain Name Server:    0.0.0.0
Secondary Domain Name Server: 0.0.0.0
Domain Name:

Receive RIP:                    Both
Transmit RIP:                   v2 (multicast)
Static Routes...

Address Serving Setup...
Exported Services...
Filter Sets...

```

- If you select **Filter Sets** you will be taken directly to the screen for configuring IP packet filters. For information see [“About filters and filter sets,”](#) beginning on page 14-4.

## IP subnets

The IP Subnets screen allows you to configure up to eight Ethernet IP subnets on unlimited-user models, one “primary” subnet and up to seven secondary subnets, by entering IP address/subnet mask pairs:

```

                                IP Subnets

      IP Address                Subnet Mask
      -----                -----
#1:  192.128.117.162          255.255.255.0
#2:  0.0.0.0                  0.0.0.0
#3:
#4:
#5:
#6:
#7:
#8:

```

**Note:** You need not use this screen if you have only a single Ethernet IP subnet. In that case, you can continue to enter or edit the IP address and subnet mask for the single subnet on the IP Setup screen.

This screen displays up to eight rows of two editable columns, preceded by a row number between one and eight. If you have eight subnets configured, there will be eight rows on this screen. Otherwise, there will be one more row than the number of configured subnets. The last row will have the value 0.0.0.0 in both the IP address and subnet mask fields to indicate that you can edit the values in this row to configure an additional subnet. All eight row labels are always visible, regardless of the number of subnets configured.

- To add an IP subnet, enter the Netopia R7200's IP address on the subnet in the **IP Address** field in a particular row and the subnet mask for the subnet in the **Subnet Mask** field in that row.

For example:

IP Subnets		
	IP Address	Subnet Mask
#1:	192.128.117.162	255.255.255.0
#2:	192.128.152.162	255.255.0.0
#3:	0.0.0.0	0.0.0.0
#4:		
#5:		
#6:		
#7:		
#8:		

- To delete a configured subnet, set both the IP address and subnet mask values to 0.0.0.0, either explicitly or by clearing each field and pressing Return to commit the change. When a configured subnet is deleted, the values in subsequent rows adjust up to fill the vacant fields.

Note that the subnets configured on this screen are tied to the address serving pools configured on the IP Address Pools screen, and that changes on this screen may affect the IP Address Pools screen. In particular, deleting a subnet configured on this screen will delete the corresponding address serving pool, if any, on the IP Address Pools screen.

If you have configured multiple Ethernet IP subnets, the IP Setup screen changes slightly:

```

                                IP Setup

Subnet Configuration...

Default IP Gateway:                192.128.117.163

Primary Domain Name Server:        0.0.0.0
Secondary Domain Name Server:      0.0.0.0
Domain Name:

Receive RIP:                        Both
Transmit RIP:                        v2 (multicast)
Static Routes...

Address Serving Setup...
Exported Services...
Filter Sets...

```

The IP address and Subnet mask items are hidden, and the **Define Additional Subnets...** item becomes **Subnet Configuration...**. If you select **Subnet Configuration**, you will return to the IP Subnets screen that allows you to define IP addresses and masks for additional Ethernet IP subnets.

## Static routes

Static routes are IP routes that are maintained manually. Each static route acts as a pointer that tells the Netopia R7200 how to reach a particular network. However, static routes are used only if they appear in the IP routing table, which contains all of the routes used by the Netopia R7200 (see ["IP routing table" on page 13-8](#)).

Static routes are helpful in situations where a route to a network must be used and other means of finding the route are unavailable. For example, static routes are useful when you cannot rely on RIP.

To go to the Static Routes screen, select **Static Routes** in the IP Setup screen and press Return.

## 10-18 User's Reference Guide

The Static Routes screen will appear.

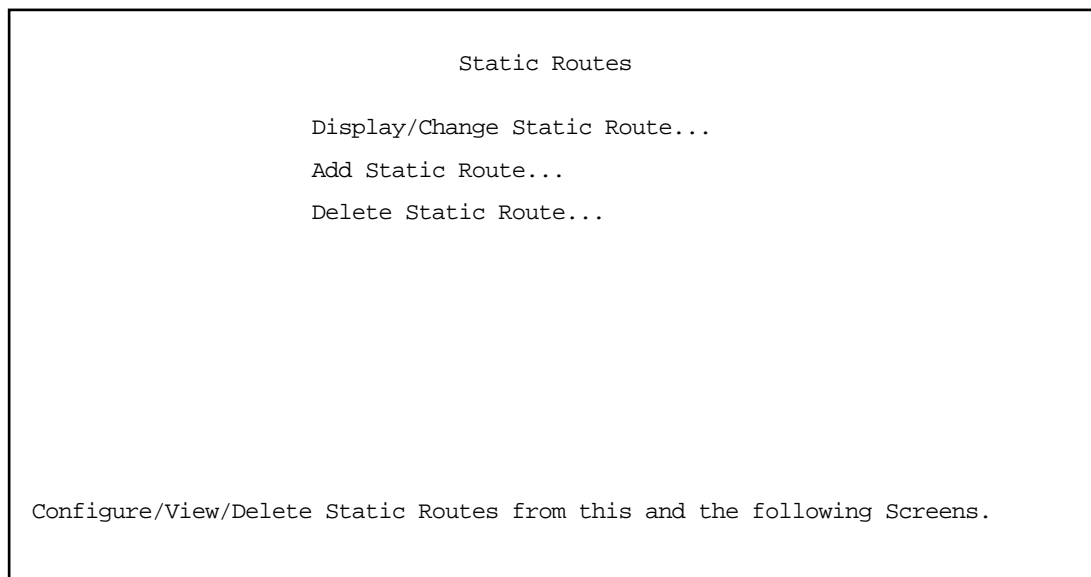

### Viewing static routes

To display a view-only table of static routes, select **Display/Change Static Route**. The table shown below will appear.

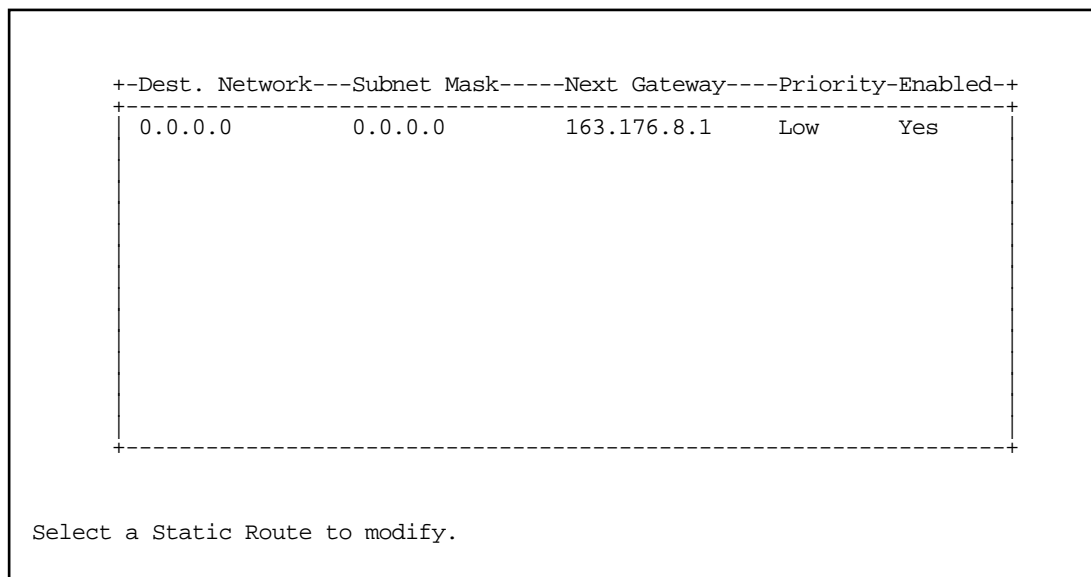

The table has the following columns:

**Dest. Network:** The network IP address of the destination network.

**Subnet Mask:** The subnet mask associated with the destination network.

**Next Gateway:** The IP address of the router that will be used to reach the destination network.

**Priority:** An indication of whether the Netopia R7200 will use the static route when it conflicts with information received from RIP packets.

**Enabled:** An indication of whether the static route should be installed in the IP routing table.

To return to the Static Routes screen, press Escape.

### *Adding a static route*

To add a new static route, select **Add Static Route** in the Static Routes screen. The Add Static Route screen will appear.

Add Static Route

Static Route Enabled:	Yes
Destination Network IP Address:	0.0.0.0
Destination Network Subnet Mask:	0.0.0.0
Next Gateway IP Address:	0.0.0.0
Route Priority...	High
Advertise Route Via RIP:	No

ADD STATIC ROUTE NOW
CANCEL

Configure a new Static Route in this Screen.

- To install the static route in the IP routing table, select **Static Route Enabled** and toggle it to **Yes**. To remove the static route from the IP routing table, select **Static Route Enabled** and toggle it to **No**.
- Be sure to read the rules on the installation of static routes in the IP routing table. See [“Rules of static route installation”](#) on page 10-20.
- Select **Destination Network IP Address** and enter the network IP address of the destination network.
- Select **Destination Network Subnet Mask** and enter the subnet mask used by the destination network.
- Select **Next Gateway IP Address** and enter the IP address for the router that the Netopia R7200 will use to reach the destination network. This router does not necessarily have to be part of the destination network, but it must at least know where to forward packets destined for that network.
- Select **Route Priority** and choose **High** or **Low**. **High** means that the static route takes precedence over RIP

information; **Low** means that the RIP information takes precedence over the static route.

- If the static route conflicts with a connection profile, the connection profile will always take precedence.
- To make sure that the static route is known only to the Netopia R7200, select **Advertise Route Via RIP** and toggle it to **No**. To allow other RIP-capable routers to know about the static route, select **Advertise Route Via RIP** and toggle it to **Yes**. When Advertise Route Via RIP is toggled to **Yes**, a new item called **RIP Metric** appears below **Advertise Route Via RIP**.

With RIP Metric you set the number of routers, from 1 to 15, between the sending router and the destination router. The maximum number of routers on a packet's route is 15. Setting **RIP Metric** to **1** means that a route can involve 15 routers, while setting it to **15** means a route can only involve one router.

- Select **ADD STATIC ROUTE NOW** to save the new static route, or select **CANCEL** to discard it and return to the Static Routes screen.
- Up to 16 static routes can be created, but one is always reserved for the default gateway, which is configured using either Easy Setup or the IP Setup screen in system configuration.

### *Modifying a static route*

To modify a static route, in the Static Routes screen select **Display/Change Static Route** to display a table of static routes.

Select a static route from the table and go to the Change Static Route screen. The parameters in this screen are the same as the ones in the Add Static Route screen (see ["Adding a static route" on page 10-19](#)).

### *Deleting a static route*

To delete a static route, in the Static Routes screen select **Delete Static Route** to display a table of static routes. Select a static route from the table and press Return to delete it. To exit the table without deleting the selected static route, press Escape.

### *Rules of static route installation*

The Netopia R7200 applies certain rules before installing enabled static routes in the IP routing table. An enabled static route will not be installed in the IP routing table if any of the following conditions are true:

- The static route's **Next Gateway IP Address** matches the IP address used by a connection profile or the Netopia R7200's Ethernet port.
- The static route's **Next Gateway IP Address** matches an IP address in the range of IP addresses being distributed by MacIP or DHCP.
- The static route's **Next Gateway IP Address** is determined to be unreachable by the Netopia R7200.
- The static route's route information conflicts with a connection profile's route information.
- The connection profile associated with the static route is set for dial-in connections only, and there is no incoming call connected to that connection profile.
- The connection profile associated with the static route has a disabled dial-on-demand setting, and there is no current connection using that connection profile.

A static route that is already installed in the IP routing table will be removed if any of the conditions listed above become true for that static route. However, an enabled static route is automatically reinstalled once the conditions listed above are no longer true for that static route.

## IP address serving

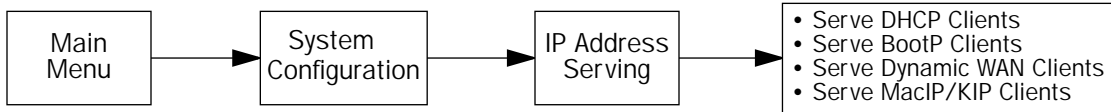

In addition to being a router, the Netopia R7200 is also an IP address server. There are four protocols it can use to distribute IP addresses.

- The first, called Dynamic Host Configuration Protocol (DHCP), is widely supported on PC networks, as well as Apple Macintosh computers using Open Transport and computers using the UNIX operating system. Addresses assigned via DHCP are “leased” or allocated for a short period of time; if a lease is not renewed, the address becomes available for use by another computer. DHCP also allows most of the IP parameters for a computer to be configured by the DHCP server, simplifying setup of each machine.
- The second, called BootP (also known as Bootstrap Protocol), is the predecessor to DHCP and allows older IP hosts to obtain most of the information that a DHCP client would obtain. However, in contrast, BootP address assignments are “permanent” since there is no lease renewal mechanism in BootP.
- The third protocol, called Dynamic WAN, is part of the PPP/MP suite of wide area protocols used for WAN connections. It allows remote terminal adapters and NAT-enabled routers to be assigned a temporary IP address for the duration of their connection.
- The fourth protocol, called MacIP, is used only for computers on AppleTalk networks. MacIP provides a protocol translation (or gateway) function between IP and AppleTalk as well as an IP address assignment mechanism. Like DHCP, MacIP address assignments are normally temporary, although you can also use static IP addresses with MacIP.

Since no two hosts can use the same IP address at the same time, make sure that the addresses distributed by the Netopia R7200 and those that are manually configured are not the same. Each method of distribution must have its own exclusive range of addresses to draw from.

## 10-22 User's Reference Guide

Go to the System Configuration screen. Select **IP Address Serving** and press Return. The IP Address Serving screen will appear.

```

                                IP Address Serving

Number of Client IP Addresses:      5
1st Client Address:                 176.163.222.10
Client Default Gateway...           176.163.222.1

Serve DHCP Clients:                 Yes
DHCP NetBios Options...

Serve BOOTP Clients:                Yes

Serve MacIP/KIP Clients:            Yes
MacIP/KIP Static Options...
```

Follow these steps to configure IP Address Serving:

- If you enabled IP Address Serving, then DHCP, BootP clients, Dynamic WAN clients, and MacIP/KIP clients (if you have the AppleTalk kit installed) are automatically enabled.
- Select **Number of Client IP Addresses** and enter the total number of contiguous IP addresses that the Netopia R7200 will distribute to the client machines on your local area network. twelve-user models are limited to twelve IP addresses.
- In the screen example shown above, five Client IP addresses have been allocated.
- Select **1st Client Address** and enter the first client IP address that you will allocate to your first client machine. For instance, on your local area network you may want to first figure out which machines are going to be allocated specific static IP addresses so that you can determine the pool of IP addresses that you will be serving addresses from via DHCP, BootP, Dynamic WAN, and/or MacIP.  
**Example:** Your ISP has given your Netopia R7200 the IP address 192.168.6.137, with a subnet mask of 255.255.255.248. The subnet mask allocated will give you six IP addresses to use when connecting to the ISP over the Internet (for more information on IP addressing refer to [Appendix B, "Understanding IP Addressing."](#)). Your address range will be from **.137-.143**. In this example you would enter **192.168.6.138** as the 1st Client Address, since the router itself must have an IP address.
- To enable DHCP, select **Serve DHCP Clients** and toggle it to **Yes**. DHCP serving is automatic when IP Address Serving is enabled.



If you have configured multiple Ethernet IP subnets, the appearance of the IP Address Serving screen is altered slightly:

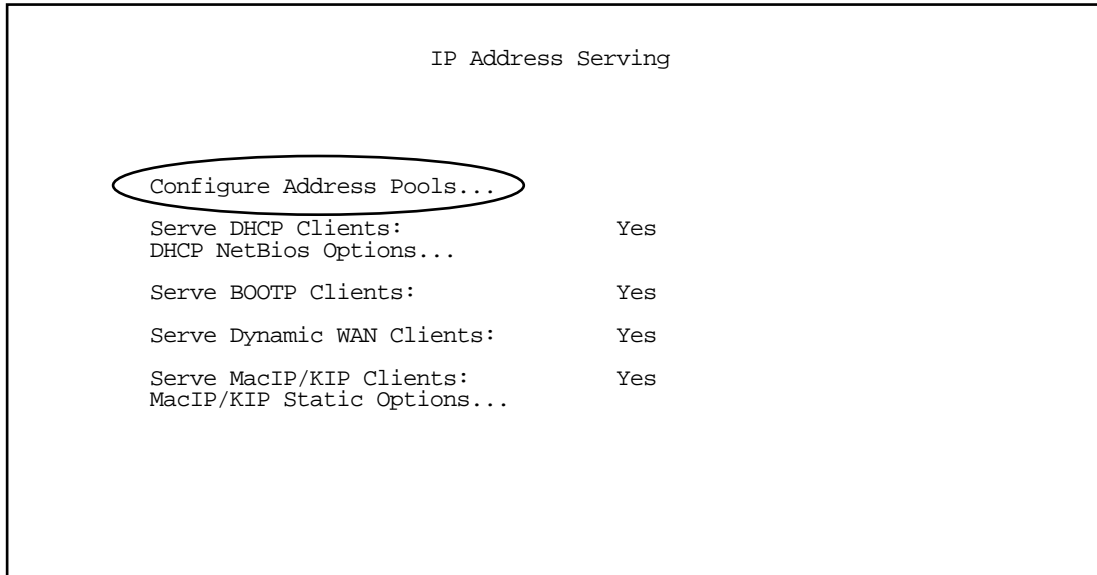

The first three menu items are hidden, and **Configure Address Pools...** appears instead. If you select **Configure Address Pools...** you will be taken to the IP Address Pools screen that allows you to configure an address serving pool for each of the configured Ethernet IP subnets. See ["IP Address Pools" on page 10-24](#).

## IP Address Pools

The IP Address Pools screen allows you to configure a separate IP address serving pool for each of up to eight configured Ethernet IP subnets:

IP Address Pools			
Subnet (# host addrs)	1st Client Addr	Clients	Client Gateway
192.128.117.0 (253)	192.128.117.196	16	192.128.117.162
192.129.117.0 (253)	192.129.117.110	8	192.129.117.4

This screen consists of between two and eight rows of four columns each. There are exactly as many rows as there are Ethernet IP subnets configured on the IP Subnets screen.

- The **Subnet (# host addrs)** column is non-selectable and non-editable. It indicates the network address of the Ethernet IP subnet for which an address pool is being configured and the number of host addresses available on the subnet. The network address is equal to the router's IP address on the subnet bitwise-ANDed with the subnet mask. The host address count is equal to the subnet size minus three, since one address is reserved for the network address, one for the subnet broadcast address, and one for the router's interface address on the subnet.

You can edit the remaining columns in each row.

- The **1st Client Addr** and **Clients** columns allow you to specify the base and extent of the address serving pool for a particular subnet. Entering 0.0.0.0 for the first client address or 0 for the number of clients indicates that no addresses will be served from the corresponding Ethernet IP subnet.
- The Client Gateway column allows you to specify the default gateway address that will be provided to clients served an address from the corresponding pool. The value defaults to the Netopia R7200's IP address on the corresponding subnet (or the Netopia R7200's default gateway, if that gateway is located on the subnet in question). You can override the value by entering any address that is part of the subnet.

DHCP, BootP, dynamic WAN, and dynamic MacIP clients may receive an address from any one of the address serving pools configured on this screen. Static MacIP clients are not "served" addresses, but must be manually configured with addresses from within the specific range of addresses reserved for that purpose on the MacIP (KIP) Forwarding Setup screen. See "[MacIP \(KIP forwarding\) setup](#)" on page 10-28.

Numerous factors influence the choice of served address. It is difficult to specify the address that will be served to a particular client in all circumstances. However, when the address server has been configured, and the clients involved have no prior address serving interactions, the Netopia R7200 will generally serve the first unused address from the first address pool with an available address. The Netopia R7200 starts from the pool on the first row and continues to the pool on the last row of this screen.

Once the address server and/or the clients have participated in address serving transactions, different rules apply:

- When requesting an address, a client will often suggest an address to be assigned, such as the one it was last served. The Netopia R7200 will attempt to honor this request if the address is available. The client stores this address in non-volatile storage, for example, on disk, and the specific storage method/location differs depending on the client operating system.
- When requesting an address, a client may provide a client identifier, or, if it does not, the Netopia R7200 may construct a pseudo-client identifier for the client. When the client subsequently requests an address, the Netopia R7200 will attempt to serve the address previously associated with the pseudo-client identifier. This is normally the last address served to the client.
- Otherwise, the Netopia will select the least-recently used available address, starting from the first address in the first pool and ending with the last address in the last pool.

**Note:** The address serving pools on this screen are tied to the IP subnets configured on the IP Subnets screen. Changes to the IP Subnets screen may affect this screen. In particular, deleting a subnet on the IP Subnets screen will delete the corresponding address serving pool, if any, on this screen.

## DHCP NetBIOS Options

If your network uses NetBIOS, you can enable the Netopia R7200 to use DHCP to distribute NetBIOS information.

NetBIOS stands for Network Basic Input/Output System. It is a layer of software originally developed by IBM and Sytek to link a network operating system with specific hardware. NetBIOS has been adopted as an industry standard. It offers LAN applications a variety of "hooks" to carry out inter-application communications and data transfer. Essentially, NetBIOS is a way for application programs to talk to the network. To run an application that works with NetBIOS, a non-IBM network operating system or network interface card must offer a NetBIOS emulator. Many vendors either provide a version of NetBIOS to interface with their hardware or emulate its transport layer communications services in their network products. A NetBIOS emulator is a program provided by NetWare clients that allow workstations to run applications that support IBM's NetBIOS calls.

- Select **DHCP NetBios Options** and press Return. The DHCP NetBIOS Options screen appears.

DHCP NetBios Options

Serve NetBios Type:	Yes
NetBios Type...	Type B
Serve NetBios Scope:	No
NetBios Scope:	
Serve NetBios Name Server:	No
NetBios Name Server IP Addr:	0.0.0.0

Configure DHCP-served NetBIOS options here.

- To serve DHCP clients with the type of NetBIOS used on your network, select **Serve NetBios Type** and toggle it to **Yes**.

- From the **NetBios Type** pop-up menu, select the type of NetBIOS used on your network.

DHCP NetBios Options

Serve NetBios Type:	+-----+
NetBios Type...	+-----+
	Type B
	Type P
Serve NetBios Scope:	Type M
NetBios Scope:	Type H
	+-----+
Serve NetBios Name Server:	No
NetBios Name Server IP Addr:	0.0.0.0

- To serve DHCP clients with the NetBIOS scope, select **Serve NetBios Scope** and toggle it to **Yes**.  
Select **NetBios Scope** and enter the scope.
- To serve DHCP clients with the IP address of a NetBIOS name server, select **Serve NetBIOS Name Server** and toggle it to **Yes**.  
Select **NetBios Name Server IP Addr** and enter the IP address for the NetBIOS name server.  
You are now finished setting up DHCP NetBIOS Options. To return to the IP Address Serving screen, press Escape.
- To enable BootP's address serving capability, select **Serve BOOTP Clients** and toggle to **Yes**.

**Note:** Addresses assigned through BootP are permanently allocated from the IP Address Serving pool until you release them. To release these addresses, navigate back to the Main Menu, then Statistics & Logs, Served IP Addresses, and Lease Management.

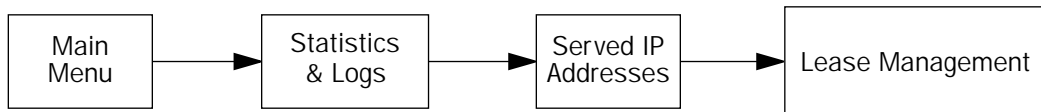

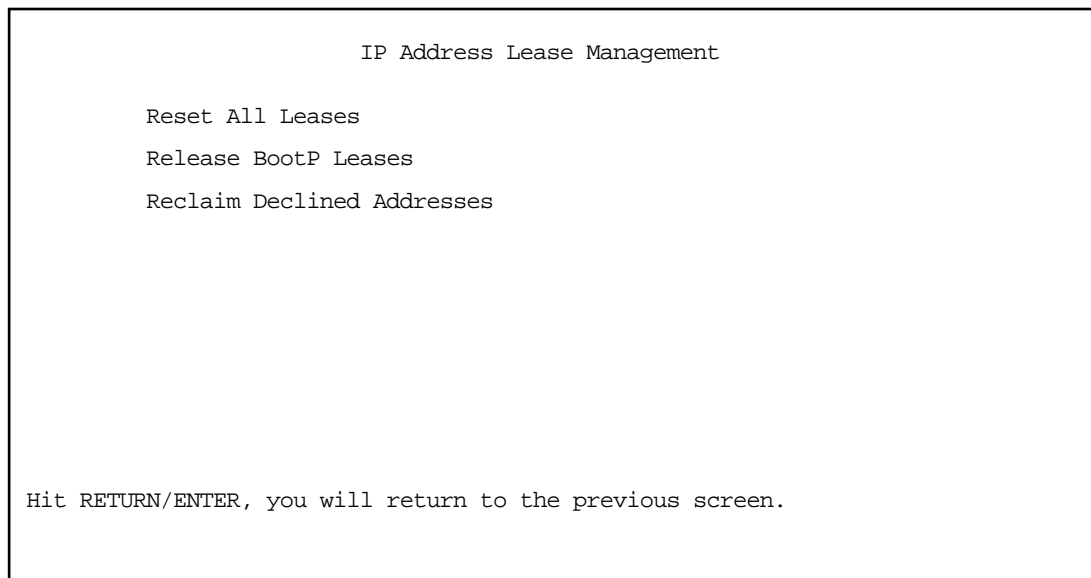

Select **Release BootP Leases** and press Return.

### *MacIP (KIP forwarding) setup*

When hosts using AppleTalk (typically those using LocalTalk) are not directly connected to an IP network (usually an Ethernet), they must use a MacIP (AppleTalk–IP) gateway.

The optional Netopia AppleTalk feature enhancement kit provides for this service. A MacIP gateway converts network traffic into the correct format for AppleTalk or IP, depending on the traffic's destination. The MacIP gateway can also distribute IP addresses to AppleTalk computers on the network.

**Note:** Macintosh computers that have LocalTalk or EtherTalk selected in the MacTCP control panel, or "AppleTalk (MacIP)" selected in the TCP/IP control panel, must use the MacIP gateway to communicate with the Internet or any other IP network. Users should point their MacTCP or TCP/IP control panel to look in the LocalTalk zone for the MacIP server. Macintosh computers that have Ethernet selected in the MacTCP or TCP/IP control panel can do their own AppleTalk–IP conversions.

Setting up MacIP involves choosing MacIP dynamic address serving and then configuring that type. KIP forwarding is simply a method for distributing IP addresses to AppleTalk clients.

- In the IP Address Serving screen, select **Serve Mac IP/KIP Clients** and toggle to **Yes** to enable MacIP/KIP address serving capability. This option is automatically enabled if the AppleTalk kit is installed and IP Address Serving is enabled.
- Select **MacIP/KIP Static Options** and press Return. The MacIP/KIP Forwarding screen appears.

The MacIP (KIP) Forwarding Setup screen tells the Netopia R7200 how many static addresses to allocate for MacIP/KIP clients. The addresses must fall within the address pool from the previous screen.

- Enter the number of static MacIP addresses to reserve.

Note that the address pool IP range is listed for your referral in this screen.

MacIP (KIP) Forwarding Setup

This screen tells the Netopia how many static addresses to allocate for MacIP/KIP clients. The addresses must fall within one of the address pools from the previous screen.

Number of Static Addresses:	0
First Static Client Address:	0.0.0.0

Enter the number of static MacIP addresses to reserve here.  
Reserve static MacIP addresses for KIP Forwarding here.

You have finished your IP setup.





# Chapter 11

## IPX Setup

Internetwork Packet Exchange (IPX) is the network protocol used by Novell NetWare networks. This chapter shows you how to configure the Netopia R7200 for routing data using IPX. You also learn how to configure the router to serve IPX network addresses.

This section covers the following topics:

- “IPX features” on page 11-1
- “IPX definitions” on page 11-1
- “IPX setup screen” on page 11-3
- “IPX routing tables” on page 11-5

---

### IPX features

The Netopia R7200 supports the following IPX features:

- IPX RIP and SAP
- NetBIOS broadcast packet forwarding (IPX type 20)
- IPX packet filtering definable by source and destination IPX address and socket number for added security
- IPX SAP filtering to aid in optimizing WAN bandwidth
- Dial-on-demand features:
  - Spoofing of IPX keep-alive, SPX, and server serialization packets
  - Configurable RIP/SAP timers on connection profiles

---

### IPX definitions

This section defines IPX-related protocols such as RIP, SAP, and NetBIOS, in addition to other related terms. See the next section for setup instructions.

### Internetwork Packet Exchange (IPX)

IPX is a datagram, connectionless protocol that Novell adapted from Xerox Network System's (XNS's) Internet Datagram Protocol (IDP). IPX is dynamically routed, and the routing architecture works by “learning” network addressing automatically.

## IPX address

An IPX address consists of a network number, a node number, and a socket number. An IPX network number is composed of eight hexadecimal digits. The network number must be the same for all nodes on a particular physical network segment. The node number is composed of twelve hexadecimal digits and is usually the hardware address of the interface card. The node number must be unique inside the particular IPX network. Socket numbers correspond to the particular service being accessed.

## Socket

A socket in IPX is the equivalent of a port in TCP/IP. Sockets route packets to different processes within a single node. Novell has reserved several sockets for use in the NetWare environment:

Field Value	Packet Type	Description
00h	Unknown Packet Type	Used for all packets not classified by any other type
01h	Routing Information Packet	Unused for RIP packets
04h	Service Advertising Packet	Used for SAP packets
05h	Sequenced Packet	Used for SPX packets
11h	NetWare Core Protocol Packet	Used for NCP packets
14h	Propagated Packet	Used for Novell NetBIOS

## Routing Information Protocol (RIP)

RIP, which was also derived from XNS, is a protocol that allows for the bidirectional transfer of routing tables and provides timing information (ticks), so that the fastest route to a destination can be determined. IPX routers use RIP to create and dynamically maintain databases of internetwork routing information. See ["IPX routing tables" on page 11-5](#) for more information.

## Service Advertising Protocol (SAP)

SAP is a protocol that provides servers and routers with a method for exchanging service information. Using SAP, servers advertise their services and addresses. Routers collect this information to dynamically update their routing tables and share it with other routers. These broadcasts keep all routers on the internetwork synchronized and provide real-time information on accessible servers on the internetwork.

The following is a list of common SAP server types:

Unknown	0000h
Print Queue	0003h
File Server	0004h
Job Server	0005h
Print Server	0007h
Archive Server	0009h
Remote Bridge Server	0024h
Advertising Print Server	0047h
Reserved Up To	8000h

## NetBIOS

NetBIOS is a protocol that performs tasks related to the Transport and Session layers of the OSI model. It can operate over IPX using a special broadcast packet known as "IPX Packet type 20" to communicate with IPX NetBIOS servers.

## IPX spoofing

The Netopia R7200 has several IPX features designed to restrict the traffic on the dial-up link when the unit is not sending or receiving IPX data. When the link is idle and a user is logged into a Novell server, the server will send keep-alive packets to ensure that the user is still there. If the link is idle, the keep-alive packets will be sent back to the server by the locally connected Netopia R7200 as though they came back from the user without bringing up the dial-up link.

SPX keep-alive packets are also treated in this manner. IPX RIP and SAP messages will not be sent if the link is down. Together, these features enable the user to remain connected to a Novell server or SPX peer without bringing up the dial-up link, except to send and receive actual user data.

---

## IPX setup screen

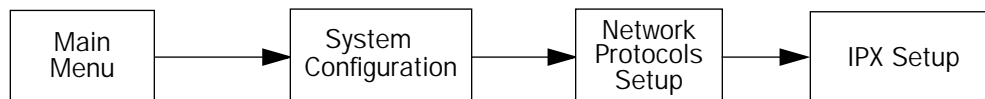

You will use the IPX Setup screen to configure the Ethernet side of the Netopia R7200. The information you enter controls how the router routes IPX traffic.

Before changing any of the settings in this screen, consult your network administrator for the IPX setup information you will need. Changes made in this screen will take effect only after the Netopia R7200 is reset.

To go to the IPX Setup screen, from the Main Menu select **System Configuration** and then select **Network Protocols Setup** and then select **IPX Setup**.

**Note:** If you have completed Easy Setup, the information you have already entered will appear in the IP Setup options screen.

```

                                     IPX Setup

IPX Routing:                          On
Ethernet Encapsulation...             802.3
Ethernet Network Address:            00000000

Ethernet Path Delay:                  1
Ethernet NetBios Forwarding:         No
Ethernet Inbound SAP Filter Set...   <<NONE>>

Default Gateway Address:              00000000

Filters and Filter Sets...

IPX Wan Pool Base Address             00000000

Return/Enter accepts * Tab toggles * ESC cancels.
Set up the basic IPX attributes of your Netopia in this screen.
```

1. To enable IPX routing, select **IPX Routing**, toggle it to **On**, and press Return.
2. To change Ethernet encapsulation from the commonly used 802.3 standard, select **Ethernet Encapsulation** and choose a different encapsulation method.
3. Select **Ethernet Network Address** and enter the network address of the IPX network connected to the Netopia R7200's Ethernet port.

**Note:** If the Ethernet network address is set to zero, the router will attempt to learn the address from any configured IPX device on the Ethernet network or from the remote IPX network when a call is established.

4. To change the default path delay, select **Ethernet Path Delay** and enter a value (in ticks). This value is used to determine the port cost of using the Ethernet port in IPX RIP calculations.
5. To enable NetBIOS packet forwarding, select **Ethernet NetBios Forwarding** and toggle it to **Yes**. This parameter will determine whether IPX Packet type 20 packets are forwarded on the Ethernet interface. These packets are used by NetBIOS and some other applications.
6. Select **Ethernet Inbound SAP Filter Set** to filter incoming IPX SAP advertisements on the Ethernet. By attaching an incoming SAP filter on the Ethernet, you can restrict the number of SAP entries learned on a large IPX network to only those required by remote users connecting to the Netopia R7200. An Ethernet SAP filter *must* be used with networks that have so many servers advertised that the Netopia R7200 would otherwise exhaust its internal memory storing server entries.

To attach a SAP filter set, first define the filter set using the **Filters and Filter Sets** option (see step 8 below). Then select the filter set from the **Ethernet Incoming SAP Filter Set** pop-up menu. To detach the filter set, select **Detach Filter Set**.

7. Select **Default Gateway Address** and enter the network address of the IPX network to which all packets of unknown destination address should be routed.

**Note:** The default gateway address is usually set up to match the IPX Address in your network connection profile.

8. To configure filters and filter sets, select **Filters and Filter Sets** and go to the IPX filters and filter sets screens. For information on how to configure IPX filters and filter sets, see ["IPX filters" on page 14-21](#).
9. Select **IPX Wan Pool Base Address** and enter the first IPX network address to be allocated to requesting IPX WAN clients. The base address you enter must not conflict with other IPX networks assigned to your IPX internet.

---

## IPX routing tables



IPX routing tables provide information on current IPX routes and services.

To go to the IPX Routing Table screen, select **IPX Routing Table** in the Statistics & Logs screen. This table shows detailed information about current IPX network routes.

IPX Routing Table							
Net	Addr	Hops	Ticks	Type	Status	Interface	via Router
-----SCROLL UP-----							
00000020		2	3	RIP	Active	Ethernet	00000120:00000c465c2f
00000030		2	12	RIP	Active	Ethernet	00000120:00000c465c2f
00000033		4	14	RIP	Active	Ethernet	000000120:00000c465c2f
00000100		2	7	RIP	Active	Ethernet	00000120:00000c465c2f
00000110		1	1	RIP	Active	Ethernet	00000120:00000c465c2f
-----SCROLL DOWN-----							
UPDATE							

To go to the IPX SAP Bindery Table screen, select **IPX SAP Bindery Table** in the Statistics & Logs screen. This table shows detailed information about available IPX services and their location.



## Chapter 12

# AppleTalk Setup

This chapter discusses the concept of AppleTalk routing and how to configure AppleTalk setup for a Netopia R7200 with the AppleTalk kit installed.

AppleTalk support is available as a separate kit for the Netopia R7200 SDSL Router. Skip this chapter if you do not have the AppleTalk kit.

This section covers the following topics:

- “AppleTalk networks” on page 12-1
- “Installing AppleTalk” on page 12-4
- “Configuring AppleTalk” on page 12-6

**Note:** To take effect, all changes to AppleTalk options require a restart.

---

### AppleTalk networks

A network is a communication system that connects computers so that they share information using network services such as e-mail, print spoolers, and file servers. Information is transferred over a cabling system or WAN using a common set of protocols. You can think of the cabling system as an organization of cities, streets, and buildings and the protocols as the method of sending letters or packages, as illustrated on the following pages. A cable is the physical medium (for example, twisted pair or coaxial) over which information travels from one device to another.

### AppleTalk protocol

AppleTalk is a protocol set for local area networks developed by Apple Computer. While initially applied to the LocalTalk cabling system for connecting Macintosh computers and LaserWriter printers, it has been expanded to use other cabling systems such as Ethernet, as well as dial-up telephone networks and packet switching systems. LocalTalk was originally known as the AppleTalk Personal Network system.

Each computer or peripheral device (printer, client, file server) connected to a network is called a node and has a unique node address, which can be any number from 1 to 254. Whenever you open the Chooser or any application that communicates with other computers on your network, your application compiles a list of all node names and addresses. All you see are the names --- for example, “Paul’sMac,” “TechSportsWriter,” or “2nd Floor AppleShare” --- but your application also knows the node addresses of all these devices.

When you send information, commands, or requests to a printer, server, or another workstation, your application formats the information into units known as packets. It then attaches the correct address to the packets and sends them to the AppleTalk software on your computer, which forwards the packets across the network. Packets also include a return address so the receiver will know where to reply.

## 12-2 User's Reference Guide

If the cabling of your network were a street system, then a node address would correspond to a building's street address. But node addresses are not permanent. Each AppleTalk device determines its node address at startup. Although a Macintosh that is starting up will try to use its previous address, the address will often be different upon restart. This dynamic node addressing scheme prevents conflicts when devices are moved between networks and simplifies the administrative tasks of a network. If you have only one network, the node address alone is all the information AppleTalk needs to send a packet from one computer to another.

However, networks can be connected together through routers, such as the Netopia R7200, into an internetwork (often shortened to internet). Because devices on different networks can have duplicate node numbers, AppleTalk tells them apart according to an additional part of their addresses: the network number.

The Netopia R7200 assigns a unique network number to each member network. In terms of the city street metaphor, the network number is similar to the name of the street. Putting a network number together with a node number fully specifies the address of a node on an internet.

To make the services on an internet manageable, groups of devices on a network can be grouped into zones. When this is done, selecting a network service (server, etc.) includes choosing a zone from which the service can be selected. Like network numbers, zone names are assigned by routers.

A routing table is maintained by each AppleTalk router. The table serves as a map of the internet, specifying the path and distance, in hops, between its router and other networks. The routing table is used to determine whether a router will forward a data packet and, if so, to which network.

You can use the information in the AppleTalk routing table to observe and diagnose the Netopia R7200's current connections to other AppleTalk routers. To go to the AT Routing Table screen from the Netopia R7200's console, select **Statistics & Logs** from the Main Menu and then select **AppleTalk Routing Table**. An AT Routing Table similar to the one shown below appears.

AT Routing Table						
Net	Range	Def	Zone Name	Hops	State	Next Rtr Addr. Pkts Fwded
				SCROLL UP		
1	--		Admin	2	Good	46.131 0
2	--		AdMan	2	Good	46.131 0
3	--		Aspirations	2	Good	46.131 0
4	--		Sales	2	Good	46.131 0
5	--		Marketing	2	Good	46.131 0
6	--		Molluscs	2	Good	46.131 1
7	--		Customer Service	2	Good	46.131 1
8	--		Telemarketing	2	Good	46.131 0
10	--		Rio	2	Good	46.131 0
11	--		Regiment	2	Good	46.131 0
12	--		Rhinos	2	Good	46.131 0
16	--		Unique Services	2	Good	46.131 0
*24	27		Aspirations	1	Good	46.131 79
28	31		Rhinos	1	Good	46.131 15
				SCROLL DOWN		
UPDATE						
'*' Entries have multiple zone names. Return/Enter on these to see zone list.						

A router has multiple communications ports and is capable of forwarding information to other routers and devices on the internet. The router performs packet forwarding, network and device address maintenance, and other administrative functions required by the AppleTalk protocols.



## MacIP

When Macintosh computers encapsulate TCP/IP packets in AppleTalk, because they are either on LocalTalk or EtherTalk, they must use the services of a MacIP gateway. This gateway converts network traffic into the correct format for AppleTalk or IP, depending on the traffic's destination. Setting up MacIP involves enabling the feature and optionally setting up a range of addresses to be static.

See ["IP address serving" on page 10-21](#) for more information on how to set up MacIP and other IP addressing schemes.

## AURP

AppleTalk Update-Based Routing Protocol (AURP) allows AppleTalk networks to communicate across an IP network. Your local AppleTalk networks (connected to the Netopia R7200) can exchange data with remote AppleTalk networks that are also connected to an AURP-capable router.

When two networks using AppleTalk communicate with each other through a network based on the Internet Protocol, they are said to be tunneling through the IP network. The Netopia R7200 uses AURP to allow your AppleTalk network to tunnel to designated AppleTalk partner networks, as well as to accept connections from remote AppleTalk networks tunneling to your AppleTalk LAN.

## Routers and seeding

To configure AppleTalk networks, you must understand the concept of seeding. Seeding is the process by which routers (or more specifically, router ports) agree on which routing information is valid. AppleTalk routers that have been reset, for example, must decide which zones and network numbers are valid before they begin routing. In this case, a router may use the information it has stored or information it receives from another router, depending on how it has been configured.

To help ensure agreement between routers on a network, a seed router is configured with the correct information, and other routers obtain their information from that router when they are turned on or reset.

Routers commonly use one of three types of seeding procedures: hard seeding, soft seeding, and non-seeding.

**Hard seeding:** When a router that uses hard seeding is turned on or reset, it requests network number and zone name information from any existing routers on the networks it will serve. If no other routers reply, the router uses the network numbers and zone names specified in its own configuration. If other routers reply, and their information matches the router's own configuration information, the result is the same—the router uses the values in its own configuration. However, if other routers provide network numbers or zone names that conflict with those in the router's configuration, the router disables any of its own ports for which there are conflicts.

**Soft seeding:** When a router that uses soft seeding is turned on or reset, it requests network number and zone name information from any existing routers on the networks it will serve. If no other routers reply, the router uses the network numbers and zone names specified in its own configuration. If other routers reply, the router uses the information they provide, regardless of whether or not there are conflicts between the information received and its configured information. Once a soft- or hard-seeding router begins to route, it can serve as a seed router, providing network number and zone name information to other routers upon request. The default state of the Netopia R7200's AppleTalk ports is soft seeding.

**Non-seeding:** When a router using non-seeding is turned on or reset, it requests network number and zone name information from any existing routers on the networks it will serve. For any network where no other routers reply, the non-seeding router will not have any active ports until the next reset.

## 12-4 User's Reference Guide

It is important to set the Netopia R7200's seeding action to work best in your particular network environment. These scenarios may guide you in deciding how to set the router's seeding:

- If the Netopia R7200 is the only router on your network, you must set it to either hard seeding or soft seeding. The default is soft seeding.
- If there is another active router on your network and you want that router to configure the Netopia R7200's EtherTalk or LocalTalk parameters, you can set the Netopia R7200 to non-seeding.
- If there is another active router on your network, you could set the Netopia R7200 to be soft seeding if you are unsure whether the second router will always be available to configure the Netopia R7200's EtherTalk or LocalTalk parameters.
- If you want the Netopia R7200 to configure the EtherTalk or LocalTalk parameters of other routers on your network, you must set it to hard seeding. In this case, the other routers must be soft seeding or non-seeding, and the Netopia R7200 must already be active when those other routers are rebooted.
- If you want the Netopia R7200 and all other routers on your network to use only their own configurations, set the Netopia R7200 and all other routers to hard seeding. In this case, any router (including the Netopia R7200) that is rebooted will not begin routing if it detects a routing conflict between itself and any other router. This last scenario could be useful for detecting and locating routing errors on your network.

---

## Installing AppleTalk

The AppleTalk kit consists of hardware and firmware components that you enable on your router in order to connect an AppleTalk network. The AppleTalk cable supplied in the AppleTalk feature expansion kit cable connects to the Auxiliary port on the Netopia R7200.

*Netopia R7200 SDSL Router back panel*

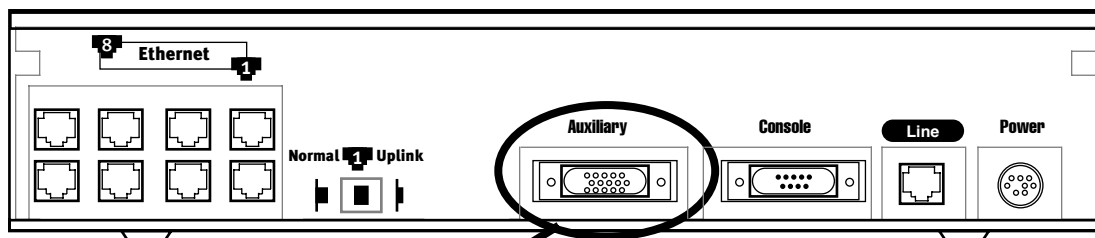

Auxiliary connection port  
HD-15 (female)

You then enable AppleTalk routing through the console-based management screens.

To install the AppleTalk features from the Main Menu, go to System Configuration and select **Upgrade Feature Set**.

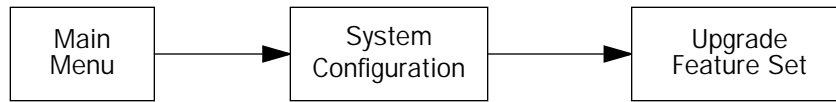

The Netopia Feature Set Upgrade screen appears.

Netopia Feature Set Upgrade

You may be able to extend the features of your Netopia by purchasing a 'Software Upgrade'. For a list of available upgrades, please see the release notes that came with your Netopia or visit the Netopia Communications web site at [www.netopia.com](http://www.netopia.com).

To purchase an upgrade, you must provide your Serial Number, which is:

xx-xx-xx

You will receive an Upgrade Key, which you should enter below.

Upgrade Key:

UPGRADE NOW                      CANCEL

Follow the instructions to enable AppleTalk on your router. Once AppleTalk is enabled, you can configure your network as described in the following sections.

## Configuring AppleTalk

AppleTalk setup for Netopia R7200s consists of configuring EtherTalk, LocalTalk, and AURP.

### EtherTalk setup

In the System Configuration screen, select **Network Protocols Setup** and then select **AppleTalk Setup**. Select **EtherTalk Phase II Setup** and press Return.

```

                                EtherTalk Phase II Setup

EtherTalk Phase II Enabled:      +-----ET II Zone List-----+
Show Zones...                   | Unnamed |
Enter New Zone Name:            |         |
Delete Zone Name...            |         |
Set Default Zone...            |         |
Net Low:                        |         |
Net Hi:                         |         |
Seeding...                      |         |
                                +-----+

Up/Down Arrow Keys to select, ESC to dismiss.

```

- If you are using EtherTalk Phase II on the Ethernet network connected to the Netopia R7200, select **EtherTalk Phase II Enabled** and toggle it to **On**.
- To view the zones available to EtherTalk Phase II, select **Show Zones** and press Return. You can dismiss the list of zones by pressing Return or Escape.
- Select **Enter New Zone Name** to enter a new zone name.

**Note:** Your EtherTalk network number and zone name must match the values in use on the EtherTalk network.

If another router is already present on the EtherTalk network that you will be connecting to the Netopia R7200, use the zone names and network numbers used by that router for that EtherTalk network. Otherwise, your EtherTalk network may experience routing conflicts. The Netopia R7200 supports creating up to 32 zone names.

As an alternative, you can set EtherTalk seeding to soft seeding and let the Netopia R7200 receive the zone name and network number from the other router.

- To remove zones from the list, select **Delete Zone Name** and press Return to see the zones list. Use the up and down arrow keys to select the zone to delete. Press Return to delete it and exit the list. Press Escape to exit the list without deleting any zones.
- Select **Set Default Zone** to choose a different default zone. This is the zone where the Netopia R7200's

EtherTalk Phase II port is visible to other AppleTalk nodes. The default zone is also where new AppleTalk nodes will appear. If you do not set a default zone, the first zone you create will be the default zone.

- You can also set the range of EtherTalk Phase II network numbers. Select **Net Low** and enter the lower limit of the network number range. Select **Net High** and enter the upper limit of the range.
- Select the **Seeding** pop-up menu and choose the seeding method for the Netopia R7200 to use. (See “Routers and seeding” on page 12-3).

You have finished configuring EtherTalk Phase II.

## LocalTalk setup

For instructions on making the physical connections for LocalTalk, see “Connecting to a LocalTalk network” on page 4-6.

In the AppleTalk Setup screen, select **LocalTalk Setup** and press Return. The LocalTalk Setup screen appears.

LocalTalk Setup

LocalTalk Enabled:	On
LocalTalk Zone Name:	Unnamed
LocalTalk Net Number:	33126
Seeding...	Soft-Seeding

Use this screen to set up the LocalTalk Port Routing attributes.

- If you are using LocalTalk with the Netopia R7200, select **LocalTalk Enabled** and make sure LocalTalk is set to **On**, which is the default.

**Note:** Since the LocalTalk connector attaches to the Auxiliary port on the router, that port will no longer be available for a third external modem.

- Select **LocalTalk Zone Name** and enter a new or existing zone name.

**Note:** Your LocalTalk network may already have a zone and network number in place. For the Netopia R7200's LocalTalk port to be part of your LocalTalk network, it must have a network number and zone name that matches the values in use on the LocalTalk network.

If another router is already present on the LocalTalk network that you will be connecting to the Netopia R7200, use the zone name and network number used by that router for that LocalTalk network. Otherwise, your LocalTalk network may experience routing conflicts.

## 12-8 User's Reference Guide

As an alternative, you can set LocalTalk seeding to soft seeding and let the Netopia R7200 receive the zone name and network number from the other router.

- Select **LocalTalk Net Number** and enter the desired network number.
- Select **Seeding**. From the pop-up menu, choose the type of seeding for the Netopia R7200's LocalTalk port to use (see "Routers and seeding" on page 12-3).

You have finished configuring LocalTalk.

### AURP setup

From the Network Protocols screen, select **AppleTalk Setup**. Then select **AURP Setup** and press Return. The AURP Setup screen appears.

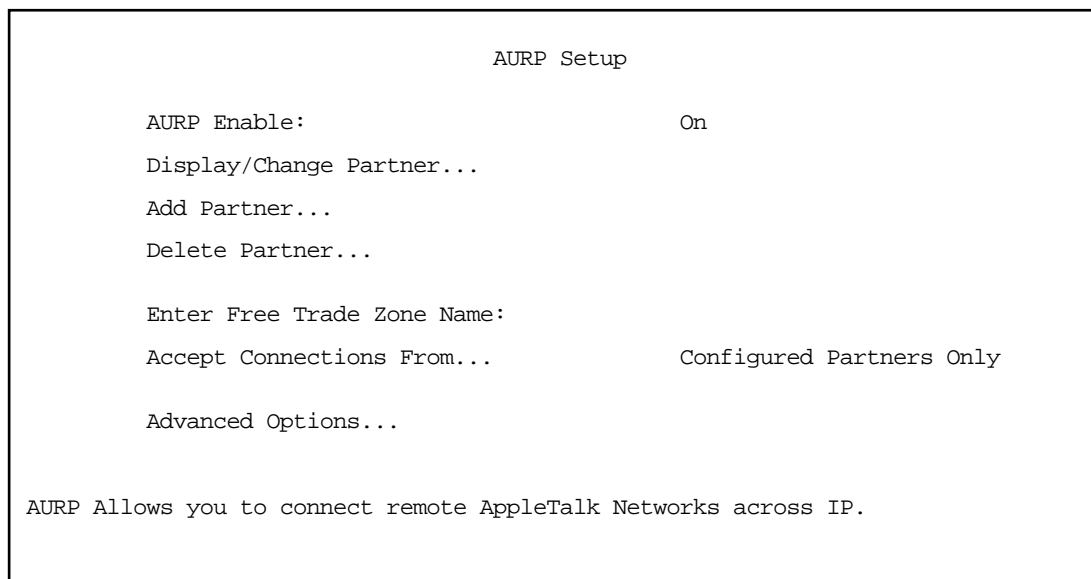

- To activate AURP and enable connections to and from AURP partners, select **AURP Enable** and toggle it to **On**.

### Viewing AURP partners

- To see a table of existing AURP partners, select **Display/Change Partner** and press Return.

**Note:** The Netopia R7200 can define a total of 32 AURP partners.

### AURP Free Trade Zone

The Free Trade Zone is an AURP security feature. It allows the Netopia administrator to specify a single AppleTalk zone that will be the only one visible to the remote side for partners that have this option enabled.

Example:

Site A has an AURP tunnel to site B. Both sites have multiple zones defined on the EtherTalk port and a unique zone on their LocalTalk ports. If side A has indicated that one of its EtherTalk zones is the Free Trade Zone and has opted to use the Free Trade Zone option for its tunnel to B, then only this Free Trade Zone will show up on side B and only those machines or services in the Free Trade Zone will be accessible to side B. All of side A will be able to see all of side B.

### Adding an AURP partner

- To add a new AURP partner, select **Add Partner** and press Return. The Add AURP Partner screen appears.

Add AURP Partner

Partner IP Address or Domain Name:

Initiate Connection:                      No

Restrict to Free Trade Zone:              No

ADD PARTNER NOW                              CANCEL

Enter Information about new Partner.

- Select **Partner IP Address or Domain Name** and enter the new AURP partner's IP address. If you do not know the remote network's IP address, enter its domain name. Domain names are the Internet addresses favored by people (for example, chagall.arts.edu). Domain names are matched to the IP addresses actually used by IP routers (for example, 163.7.8.202).
- To initiate a connection with an AURP partner, select **Initiate Connection** and toggle it to **Yes**. This will open a connection to the remote AppleTalk network after rebooting.
- You can choose to restrict this partner to the Free Trade Zone by toggling **Restrict to Free Trade Zone** to **Yes**. See "[AURP Free Trade Zone](#)" on page 12-8 for more information.
- To add the new AURP partner, select **ADD PARTNER NOW**. To discard the new AURP partner, select **CANCEL**.

### Modifying an AURP partner

- To modify an AURP partner, in the AURP Setup screen select **Display/Change Partner** and press Return. A table of existing partners appears.

Use the up and down arrow keys to select a partner, then press Return to go to the Change AURP Partner screen. The Change AURP Partner screen appears.

Change AURP Partner

Partner IP Address or Domain Name: 176.163.8.134

Initiate Connection: No

Restrict to Free Trade Zone: No

The Change AURP Partner screen has all the values you entered when you added that partner. All of these values may be modified in this screen.

### *Deleting an AURP partner*

- To delete an AURP partner, in the AURP Setup screen select **Delete Partner** and press Return. A table of existing partners appears.

Use the up and down arrow keys to select an AURP partner, then press Return to delete it. Press Escape to exit without deleting a partner.

### *Receiving AURP connections*

- To control the acceptance of incoming AURP tunnels, select **Accept Connections From** and choose **Anyone** or **Configured Partners Only** from the pop-up menu. If you choose **Anyone**, all incoming AURP connections will be accepted.

The more secure option is **Configured Partners Only**, which accepts connections only from recognized AURP partners (the ones you have set up).

### *Configuring AURP Options*

In the AURP Setup screen, select **Advanced Options** and go to the AURP Options screen. Using AURP can cause a problem when two networks, one local and one remote, have the same network number. This may cause network routing ambiguities than can result in routing errors.



AURP Options	
Tickle Interval (HH:MM:SS):	00:00:00
Update Interval (HH:MM:SS):	00:00:30
Enable Network Number Remapping:	Yes
Remap into Range	
From:	4096
To:	32768
Cluster Remote Networks:	No
Enable Hop-Count Reduction:	No

Return accepts \* ESC cancels \* Left/Right moves insertion point \* Del deletes.

- Select **Tickle Interval (HH:MM:SS)** and set the timer to indicate how often a tickle or “Are you still there” packet will be sent to the remote AppleTalk network.

The AURP tickle timer is a parameter that you can set anywhere between 0 and 100 hours. This parameter tells the AURP partners when to send out an AURP tickle packet. If this value is set to 0, the Netopia R7200 will never send out a tickle packet. Tickle packets verify that the remote router is working. The minimum tickle interval is 90 seconds. The maximum tickle interval setting is 99:59:59 (100 hours), which is the recommendation for small networks.

Raising the tickle packet interval does not ensure that the AURP tunnel is dropped or not brought up. If any application on the local network generates AppleTalk traffic destined for the network at the remote end of the AURP tunnel, the tunnel remains up. For example, if a host on the local network connects to a host on the remote network using remote access software, the AURP tunnel remains up. The AURP tunnel also remains up if a local user selects the Chooser and uses an AppleTalk service that involves a remote zone, such as mounting a remote AppleShare volume.

- In many AppleTalk internets, individual AppleTalk networks come and go. Routers are designed to notify each other at the end of their Update Interval every time there's such a change in the network topology. This will cause the Netopia's WAN link to be brought up. To minimize what may be unnecessary calls, change the **Update Interval** value to some larger value. At the end of this time window, if there has been a local AppleTalk network change, the Netopia R7200 will call any remote AURP partner and forward the new network information.

- To enable network number remapping, select **Enable Network Number Remapping** and toggle it to **Yes**.

You should enable network number remapping if you plan to use AURP when connecting to unknown AppleTalk networks; for example, when **Accept Connections from Anyone** is enabled. With remapping, the Netopia R7200 will substitute network numbers not used by your network for the numbers of other remote networks. These safe remappings will only be used by local routers on your network; remote routers will not be aware of the remapping.

## 12-12 User's Reference Guide

When network number remapping is enabled, you *must* choose a safe range of network numbers as a destination for the remapping. A safe range of network numbers does not intersect your local AppleTalk network's range of network numbers.

- To choose a destination range for the remapping, select **From** under **Remap into Range** and enter a starting value. Then select **To** and enter an ending value. Make sure the range you choose is large enough to accommodate all expected incoming AURP network numbers.
- To improve the efficiency of remapping network numbers into a safe range, select **Cluster Remote Networks** and toggle it to **Yes**. This setting takes any number of remote networks being remapped and causes them to be remapped into a continuous range.
- To override the AppleTalk maximum limit of 15 hops, select **Enable Hop-Count Reduction** and toggle it to **Yes**. Hosts on a local AppleTalk network will then see AppleTalk destinations across the IP tunnel as being only one hop away.

AppleTalk allows a packet up to 15 hops (going through 15 AppleTalk routers) to reach its destination. Packets that must reach destinations more than 15 hops away will not succeed; therefore, tunneling from one large AppleTalk network to another could exceed that limit. In such a case, hop-count reduction enables full network to network communication.

You have finished configuring AURP.

## Chapter 13

# Monitoring Tools

This chapter discusses the Netopia R7200's device and network monitoring tools. These tools can provide statistical information, report on current network status, record events, and help in diagnosing and locating problems.

This section covers the following topics:

- "Quick View status overview" on page 13-1
- "Statistics & Logs" on page 13-4
- "Event histories" on page 13-5
- "Routing tables" on page 13-7
- "Served IP Addresses" on page 13-10
- "System Information" on page 13-12
- "SNMP" on page 13-12
- "Web-based management pages" on page 13-16

---

### Quick View status overview

You can get a useful, overall status report from the Netopia R7200 in the Quick View screen. To go to the Quick View screen, select **Quick View** in the Main Menu.



The Quick View screen has three status sections:

- General status
- Current WAN Connection Status
- LED Status

The status sections vary according to the interface of your Netopia R7200.

## General status

```

                                Quick View                                12/3/1998 02:41:39 PM
Default IP Gateway: 0.0.0.0          CPU Load: 5%          Unused Memory: 602 KB
Domain Name Server: 0.0.0.0
Domain Name: netopia.com

-----MAC Address-----IP Address-----IPX Address-----
Ethernet Hub: 00-00-c5-70-03-48 192.168.1.1
SDSL WAN1: 00-00-c5-70-03-4a 0.0.0.0

                                Current DSL Status
Profile Name-----Rate--%Use-Remote Address-----Est.-More Info-----
ISP                Port1 10 IP 92.163.4.1      Lcl NAT 192.163.100.6

                                LED Status
PWR+-----WAN1-----+---CON---AUX---+-----WAN2-----+---EN---+-----LEDS-----
   LNK RDY CH1 CH2   LNK LNK   LNK RDY CH1 CH2  DATA | '-'= Off 'G'= Green
   G   -   -   -   -   Y   -   -   -   -   -   -   | 'R'= Red 'Y'= Yellow

```

**Current Date:** The current date; this can be set with the Date and Time utility (see [“Date and time”](#) on page 8-12).

**Default IP Gateway:** The router's default gateway, which may be either manually configured or learned via DHCP. This is the value you assigned in the Default IP Gateway field on [page 7-7](#). If you are using the router's defaults (DHCP and NAT) this value will be 0.0.0.0. If you have assigned an IP address as your default gateway, it is shown here.

**CPU Load:** Percentage of the system's resources being used by all current transmissions.

**Unused Memory:** The total remaining system memory available for use.

**Domain Name Server:** If you are using the router's defaults (DHCP and NAT) this value will be 0.0.0.0. If you have assigned an IP address as your default gateway, it is shown here.

**Domain Name:** The domain name you have assigned, typically the name of your ISP.

**MAC Address:** The Netopia R7200's hardware address, for those interfaces that support DHCP.

**IP Address:** The Netopia R7200's IP address, entered in the IP Setup screen.

**IPX Address:** The Netopia R7200's IPX address, entered in the IPX Setup screen.

**EtherTalk Address:** The Netopia R7200's AppleTalk address on its EtherTalk Phase II interface, entered in the EtherTalk Phase II Setup screen (only if the optional AppleTalk feature set is installed).

**LocalTalk Address:** The Netopia R7200's AppleTalk address on its LocalTalk interface, entered in the LocalTalk Setup screen (only if the optional AppleTalk feature set is installed).

## Current status

The current status section is a table showing the current status of the WAN. For example:

```

Current DSL Status
---Profile Name-----State---%Use-Remote Address---Est.-More Info-----
ISP                    P1      10 IP 92.163.4.1      Lcl NAT 192.163.100.6

```

**Profile Name:** Lists the name of the connection profile being used, if any.

**State:** Lists the ports in use for this connection.

**%Use:** Indicates the average percent utilization of the maximum capacity of the channels in use for the connection.

**Remote Address:** Shows the IP address of the connected remote router if the connection is using IP. Otherwise, shows the IPX address of the connected remote router, if using IPX.

**Est:** Indicates whether the connection was locally ("Lcl") or remotely ("Rmt") established.

**More Info:** Indicates, in order of priority, the NAT address in use for this connection, the IPX address in use (if IP is also in use), or the ISDN caller identification (if available).

## Status lights

This section shows the current real-time status of the Netopia R7200's status lights (LEDs). It is useful for remotely monitoring the router's status. The Quick View screen's arrangement of LEDs corresponds to the physical arrangement of LEDs on the router.

```

-PWR-+-----WAN1-----+---CON--AUX--+-----WAN2-----+---EN--+-----LEDS-----
      LNK RDY CH1 Ch2   LNK  LNK   LNK RDY CH1 CH2  DATA | '- '= Off 'G'= Green
      G   -   G   -   -   Y   -   -   -   -   -   -   | 'R'= Red 'Y'= Yellow

```

Each LED representation can report one of four states:

–: The LED is off.

**R:** The LED is red.

**G:** The LED is green.

**Y:** The LED is yellow.

The section [“Netopia R7200 SDSL Router status lights”](#) on page 3-4 describes the meanings of the colors for each LED.

## Statistics & Logs



When you are troubleshooting your Netopia R7200, the Statistics & Logs screens provide insight into the recent event activities of the router.

From the Main Menu go to Statistics & Logs and select one of the options described in the sections below.

### General Statistics

To go to the General Statistics screen, select **General Statistics** and press Return. The General Statistics screen appears.

General Statistics						
Phys I/F-----	Rx Bytes----	Tx Bytes----	Rx Pkts----	Tx Pkts----	Rx Err----	Tx Err----
Ethernet Hub	123456789	123456789	12345678	12345678	12345678	12345678
LocalTalk	123456789	123456789				
SDSL 1	123456789	123456789	12345678	12345678		
Network-----	Rx Bytes----	Tx Bytes----	Rx Pkts----	Tx Pkts----	Rx Err----	Tx Err----
IP	123456789	123456789	12345678	12345678	12345678	12345678
IPX	123456789	123456789	12345678	12345678	12345678	12345678
AppleTalk	123456789	123456789	12345678	12345678		

The General Statistics screen displays information about data traffic on the Netopia R7200's data ports. This information is useful for monitoring and troubleshooting your LAN. Note that the counters roll over at their maximum field width, that is, they restart again at 0.

### *Physical Interface*

The top left side of the screen lists total packets received and total packets transmitted for the following data ports:

- Ethernet Hub
- Aux Async or LocalTalk (if the optional AppleTalk feature set is installed)
- SDSL 1

### *Network Interface*

The bottom left side of the screen lists total packets received and total packets transmitted for the following protocols:

- IP (IP packets on the Ethernet)
- IPX (IPX packets on the Ethernet) if IPX is enabled
- AppleTalk (AppleTalk packets on Ethernet using EtherTalk Phase II if the optional AppleTalk feature set is installed)
- LT (LocalTalk on the PhoneNET) if the optional AppleTalk feature set is installed

The right side of the table lists the total number of occurrences of each of six types of communication statistics:

**Rx Bytes:** The number of bytes received

**Tx Bytes:** The number of bytes transmitted

**Rx Packets:** The number of packets received

**Tx Pkts:** The number of packets transmitted

**Rx Err:** The number of bad Ethernet packets received

**Tx Err:** The number of errors occurring when Ethernet packets are transmitted simultaneously by nodes on the LAN

---

## *Event histories*

The Netopia R7200 records certain relevant occurrences in event histories. Event histories are useful for diagnosing problems because they list what happened before, during, and after a problem occurs. You can view two different event histories: one for the router's system and one for the WAN. The Netopia R7200's built-in battery backup prevents loss of event history from a shutdown or reset.

The router's event histories are structured to display the most recent events first, and to make it easy to distinguish error messages from informational messages. Error messages are prefixed with an asterisk. Both the WAN Event History and Device Event History retain records of the 128 most recent events.

In the Statistics & Logs screen, select **WAN Event History**. The WAN Event History screen appears.



### WAN Event History

The WAN Event History screen lists a total of 128 events on the WAN. The most recent events appear at the top.

```

                                WAN Event History
                                Current Date -- 12/3/98 03:02:23 PM
-Date----Time----Event-----
-----SCROLL UP-----
07/03/98 13:59:06   DSL: IP up, channel 1, gateway: 173.166.107.1
07/03/98 13:59:05   DSL: Channel 1 up
07/03/98 13:59:05  >>WAN: data link activated at 1040 Kbps
07/03/98 13:58:32   --Device restarted-----
07/03/98 12:46:39   --Device restarted-----
07/03/98 11:45:57   --Device restarted-----
07/02/98 17:58:15   DSL: IP up, channel 1, gateway: 173.166.107.1
07/02/98 17:58:10   DSL: Channel 1 up
07/02/98 17:58:10  >>WAN: data link activated at 1040 Kbps
07/02/98 17:57:05   DSL: IP down, channel 1
07/02/98 17:57:05   Link 1 down: No Synch
07/02/98 17:57:05  >>WAN: data link deactivated
07/02/98 17:48:02   DSL: IP up, channel 1, gateway: 173.166.107.1
07/02/98 17:48:01   DSL: Channel 1 up
-----SCROLL DOWN-----
Clear History...

Return/Enter on event item for details or SCROLL [UP/DOWN] item for scrolling.
  
```

Each entry in the list contains the following information:

**Date:** Date of the event.

**Time:** Time of the event.

**Event:** A brief description of the event.

**Ch.:** The channel involved in the event.

**Dir. Number:** The directory number (number dialed) involved in the event (switched circuit models only).

The first event in each call sequence is marked with double arrows (>>).

Failures are marked with an asterisk (\*).

If the event history exceeds the size of the screen, you can scroll through it by using the SCROLL UP and SCROLL DOWN items.

To scroll up, select **SCROLL UP** at the top of the list and press Return. To scroll down, select **SCROLL DOWN** at the bottom of the list and press Return.



To get more information about any event listed in the WAN Event History, select the event and then press Return. A dialog box containing more information about the selected event will appear. Press Return or Escape to dismiss the dialog box.

To clear the event history, select **Clear History** at the bottom of the history screen and press Return.

### Device Event History

The Device Event History screen lists a total of 128 port and system events, giving the time and date for each event, as well as a brief description. The most recent events appear at the top.

In the Statistics & Logs screen, select **Device Event History**. The Device Event History screen appears.

```

                                Device Event History
                                Current Date -- 12/3/98 02:03:27 AM
-----Date-----Time-----Event-----
-----SCROLL UP-----
01/22/96 02:03:18  AURP initialization complete
01/22/96 02:03:18  AppleTalk initialization complete
01/22/96 02:03:11  IPX initialization complete
01/22/96 02:03:11  IP address server initialization complete
01/22/96 02:03:11  --BOOT: Warm start v4.3 -----
01/22/96 02:02:32  IPX initialization complete
01/22/96 02:02:32  IP address server initialization complete
01/22/96 02:02:32  --BOOT: Warm start v4.3 -----
01/22/96 01:59:50  * IP: Route 0.0.0.0/0.0.0.0 not installed
01/22/96 01:59:50  IPX initialization complete
01/22/96 01:59:50  IP address server initialization complete
01/22/96 01:59:50  --BOOT: Cold start v4.3 -----
01/22/96 01:55:12  AppleTalk initialization complete
01/22/96 01:55:07  * IP: Route 0.0.0.0/0.0.0.0 not installed
-----SCROLL DOWN-----
Clear History...

Return/Enter on event item for details or SCROLL [UP/DOWN] item for scrolling.

```

If the event history exceeds the size of the screen, you can scroll through it by using SCROLL UP and SCROLL DOWN.

To scroll up, select **SCROLL UP** at the top of the list and press Return. To scroll down, select **SCROLL DOWN** at the bottom of the list and press Return.

To obtain more information about any event listed in the Device Event History, select the event and then press Return. A dialog box containing more information about the selected event appears. Press Return or Escape to dismiss the dialog box.

To clear the Device Event History, select **Clear History** and press Return.

---

## Routing tables

You can view all of the IP, IPX, and AppleTalk routes in the Netopia R7200's IP, IPX, and AppleTalk routing tables, respectively.

To go to a routing table screen, select the routing table you are interested in from the Statistics & Logs screen.

Each of the routing table screens represents a snapshot of the routing table information at the time the screen is first invoked. To take a new snapshot, select **Update** at the bottom of the screen and press Return.

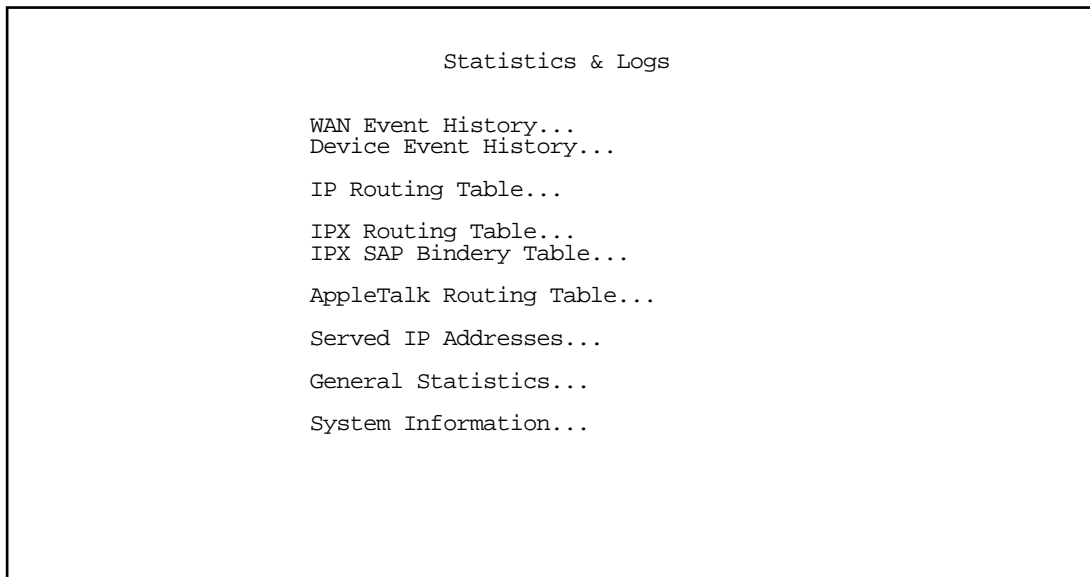

*IP routing table*

In the Statistics & Logs screen, select **IP Routing Table** and press Return.

The IP routing table displays all of the IP routes currently known to the Netopia R7200.

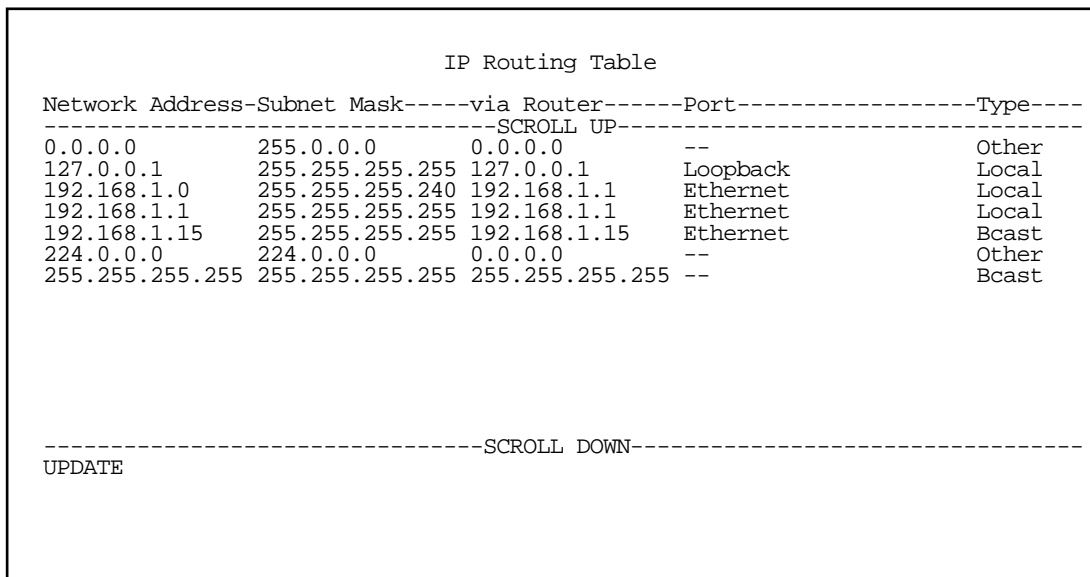

### IPX routing table

In the Statistics & Logs screen, select **IPX Routing Table** and press Return.

The IPX routing table displays all of the IPX routes currently known to the Netopia R7200.

### IPX Sap Bindery table

In the Statistics & Logs screen, select **IPX Sap Bindery Table** and press Return.

The IPX Sap Bindery table displays all of the IPX Sap Bindery routes currently known to the Netopia R7200.

### AppleTalk routing table

In the Statistics & Logs screen, select **AppleTalk Routing Table** and press Return. An AT Routing Table similar to the one shown below will appear.

The AppleTalk routing table displays information about the current state of AppleTalk networks connected to the Netopia R7200, including remote AppleTalk networks connected with AURP. This information is gathered from other active AppleTalk routers.

AT Routing Table						
-Net--	Range--	Def Zone Name-----	Hops-	State-	Next Rtr Addr.--	Pkts Fwded
-----SCROLL UP-----						
1	--	Admin	2	Good	46.131	0
2	--	AdMan	2	Good	46.131	0
3	--	Aspirations	2	Good	46.131	0
4	--	Sales	2	Good	46.131	0
5	--	Marketing	2	Good	46.131	0
6	--	Molluscs	2	Good	46.131	1
7	--	Customer Service	2	Good	46.131	1
8	--	Telemarketing	2	Good	46.131	0
10	--	Rio	2	Good	46.131	0
11	--	Regiment	2	Good	46.131	0
12	--	Rhinos	2	Good	46.131	0
16	--	Unique Services	2	Good	46.131	0
*24	27	Aspirations	1	Good	46.131	79
28	31	Rhinos	1	Good	46.131	15
-----SCROLL DOWN-----						
UPDATE						
'*' Entries have multiple zone names. Return/Enter on these to see zone list.						

The table has the following columns:

**Net:** Displays the starting network number supplied by the AppleTalk router in the **Next Rtr Addr.** column. If a network number is preceded by an asterisk (\*), it has multiple zones. To display the zones, select the network entry and press Return.

**Range:** Displays the ending network number for the extended network.

**Def Zone Name:** Displays the zone or zones associated with the specified network or network range. The zone name shown is either the only zone or the default zone name for an extended network. To see the complete list of zones for an extended network with multiple zones, select the entry in the table and press Return. Press Return again to close the list of zones.

**Hops:** Displays the number of routers between the Netopia R7200 and the specified network.

**State:** Displays the state of the specified route, based on the frequency of Routing Table Maintenance Protocol (RTMP) packets received for the route. The state can be Good, Suspect, or Bad. AppleTalk routers regularly exchange RTMP packets to update AppleTalk routing information.

**Next Rtr Addr.:** Displays the DDP or IP address of the next hop for the specified route. A DDP address is displayed if the router shown is on the local AppleTalk network. DDP address means that a connection to the next-hop router is by a native AppleTalk network (e.g., LocalTalk or EtherTalk Phase II). An IP address is displayed if the Netopia R7200 is connected to the router shown using AURP. IP address means a connection transports over AURP (AppleTalk encapsulated IP).

**Pkts Fwdded:** The number of packets sent to the router shown.

Each row in the AppleTalk routing table corresponds to an AppleTalk route or network range. If the list of routes shown exceeds the size of the screen, you can scroll through it by using SCROLL UP and SCROLL DOWN.

To scroll up, select **SCROLL UP** at the top of the table and press Return. To scroll down, select **SCROLL DOWN** at the bottom of the table and press Return.

---

## Served IP Addresses

You can view all of the IP addresses currently being served by the Netopia R7200 SDSL Router from the **Served IP Addresses** screen.

From the Statistics & Logs menu, select **Served IP Addresses**. The Served IP Addresses screen appears.

Served IP Addresses			
-IP Address-----	Type-----	Expires--	Client Identifier-----
			SCROLL UP-----
192.168.1.100	DHCP	00:36	EN: 00-00-c5-4a-1f-ea
192.168.1.101	DHCP	00:58	EN: 08-00-07-16-0c-85
192.168.1.102			
192.168.1.103			
192.168.1.104			
192.168.1.105			
192.168.1.106			
192.168.1.107			
192.168.1.108			
192.168.1.109			
192.168.1.110			
192.168.1.111			
192.168.1.112			
192.168.1.113			
			-----SCROLL DOWN-----
Lease Management...			
EN = Ethernet Address; AT = AppleTalk Address; CP = Profile Name; HX = hex			

To manage DHCP leases, select **Lease Management** in this screen.

The IP Address Lease Management screen appears.

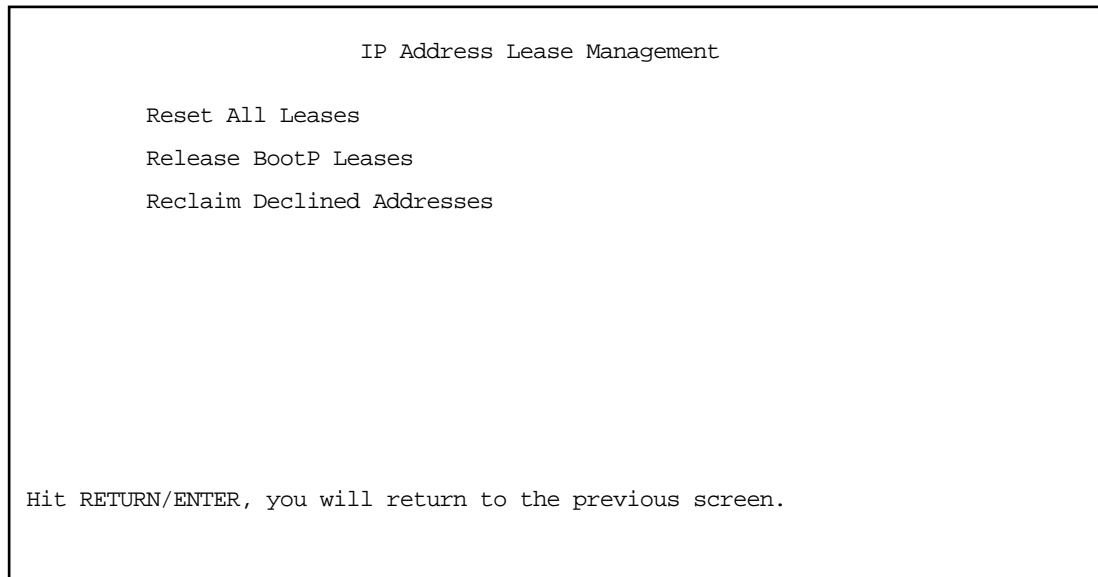

This screen has three options:

- **Reset All Leases:** Resets all current IP addresses leased through DHCP without waiting for the default one-hour lease period to elapse
- **Release BootP Leases:** Releases any BootP leases that may be in place and which may no longer be required.
- **Reclaim Declined Addresses:** Reclaims served leases that have been declined; for example by devices that may no longer be on the network.

---

## System Information

The System Information screen gives a summary view of the general system level values in the Netopia R7200 SDSL Router.

From the Statistics & Logs menu select **System Information**. The System Information screen appears.

System Information	
Serial Number	70-02-ec (7340780)
Firmware Version	4.3
Processor Speed (MHz)	33
Flash ROM Capacity (MBytes)	1
DRAM Capacity (MBytes)	4
Ethernet	8 Port 10Base-T
Auxiliary Serial Port	Switched Async
WAN 1 Interface	SDSL
WAN 2 Interface	Not Installed
AppleTalk Feature Set	Installed
User Restriction (# users)	13
Analog Dial-In Kit	Installed

The information display varies by model, firmware version, feature set, and so on. You can tell at a glance your particular system configuration.

---

## SNMP

The Netopia R7200 includes a Simple Network Management Protocol (SNMP) agent, allowing monitoring and configuration by a standard SNMP manager.

The Netopia R7200 supports the following management information base (MIB) documents:

- MIB II (RFC 1213)
- Interface MIB (RFC 1229)
- Ethernet MIB (RFC 1643)
- AppleTalk MIB I (RFC 1243)
- Netopia MIB

These MIBs are on the Netopia R7200 CD included with the Netopia R7200. Load these MIBs into your SNMP management software in the order they are listed here. Follow the instructions included with your SNMP manager on how to load MIBs.

## The SNMP Setup screen

From the Main Menu, select **SNMP** in the System Configuration screen and press Return. The SNMP Setup screen appears.

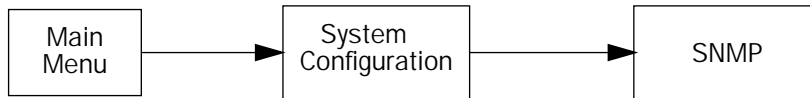

SNMP Setup

System Name:  
System Location:  
System Contact:

Read-Only Community String:                   public  
Read/Write Community String:               private

Authentication Traps Enable:               Off

IP Trap Receivers...

Configure optional SNMP parameters from here.

Follow these steps to configure the first three items in the screen:

1. Select **System Name** and enter a descriptive name for the Netopia R7200's SNMP agent.
2. Select **System Location** and enter the router's physical location (room, floor, building, etc.).
3. Select **System Contact** and enter the name of the person responsible for maintaining the router.

System Name, System Location, and System Contact set the values returned by the Netopia R7200 SNMP agent for the SysName, SysLocation, and SysContact objects, respectively, in the MIB II system group. Although optional, the information you enter in these items can help a system administrator manage the network more efficiently.

### Community strings

The **Read-Only Community String** and the **Read/Write Community String** are like passwords that must be used by an SNMP manager querying or configuring the Netopia R7200. An SNMP manager using the **Read-Only Community String** can examine statistics and configuration information from the router, but cannot modify the router's configuration. An SNMP manager using the **Read/Write Community String** can both examine and modify configuration parameters.

By default, the read-only and read/write community strings are set to public and private, respectively. You should change both of the default community strings to values known only to you and trusted system administrators.

To change a community string, select it and enter a new value.

Starting with the version 4.3 firmware, setting the Read-Only and Read-Write community strings to the empty string will block all SNMP requests to the router. (The router may still send SNMP Traps if those are properly enabled.)

Previously, if either community string was the empty string, SNMP Requests specifying an empty community string were accepted and processed.

This change is designed to allow the administrator to block SNMP access to the router and to provide more granular control over the allowed SNMP operations to the router.

- Setting only the Read-Write community string to the empty string will block SNMP Set Requests to the router, but Get Requests and Get-Next Requests will still be honored using the Read-Only community string (assuming that is not the empty string).
- Setting only the Read-Only community string to the empty string will *not* block Get Requests or Get-Next Requests since those operations (and Set Requests) are still allowed using the (non-empty) Read-Write community string.

Even if you decide not to use SNMP, you should change the community strings. This prevents unauthorized access to the Netopia R7200 through SNMP. For more information on security issues, see [“Suggested security measures” on page 14-1](#).

## SNMP traps

An SNMP trap is an informational message sent from an SNMP agent (in this case, the Netopia R7200) to a manager. When a manager receives a trap, it may log the trap as well as generate an alert message of its own.

Standard traps generated by the Netopia R7200 include the following:

- An authentication failure trap is generated when the router detects an incorrect community string in a received SNMP packet. **Authentication Traps Enable** must be **On** for this trap to be generated.
- A cold start trap is generated after the router is reset.
- An interface down trap (ifDown) is generated when one of the router's interfaces, such as a port, stops functioning or is disabled.
- An interface up trap (ifUp) is generated when one of the router's interfaces, such as a port, begins functioning.

The Netopia R7200 sends traps using UDP (for IP networks).

You can specify which SNMP managers are sent the IP traps generated by the Netopia R7200. Up to eight receivers can be set. You can also review and remove IP traps.

To go to the IP Trap Receivers screen, select **IP Trap Receivers**. The IP Trap Receivers screen appears.



### IP Trap Receivers

Display/Change IP Trap Receiver...

Add IP Trap Receiver...

Delete IP Trap Receiver...

Return/Enter to modify an existing Trap Receiver.  
Navigate from here to view, add, modify and delete IP Trap Receivers.

#### *Setting the IP trap receivers*

1. Select **Add IP Trap Receiver**.
2. Select **Receiver IP Address or Domain Name**. Enter the IP address or domain name of the SNMP manager you want to receive the trap.
3. Select **Community String** if you enabled one in the SNMP Setup screen, and enter the appropriate password.
4. Select **Add Trap Receiver Now** and press Return. You can add up to seven more receivers.

#### *Viewing IP trap receivers*

To display a view-only table of IP trap receivers, select **Display/Change IP Trap Receiver** in the IP Trap Receivers screen.

#### *Modifying IP trap receivers*

1. To edit an IP trap receiver, select **Display/Change IP Trap Receiver** in the IP Trap Receivers screen.
2. Select an IP trap receiver from the table and press Return.
3. In the **Change IP Trap Receiver** screen, edit the information as needed and press Return.

#### *Deleting IP trap receivers*

1. To delete an IP trap receiver, select **Delete IP Trap Receiver** in the IP Trap Receivers screen.
2. Select an IP trap receiver from the table and press Return.
3. In the dialog box, select **Continue** and press Return.

## Web-based management pages

The web-based management pages add significant new features for monitoring your router.

You access the web-based management pages by launching your web browser and entering the URL:

`http://router_IP_address`

where *router\_IP\_address* is the address of your router. The default address is 198.162.1.1.

The System Information page appears.

## System Information page

This is the initial page you link to when you connect to the web-based management pages.

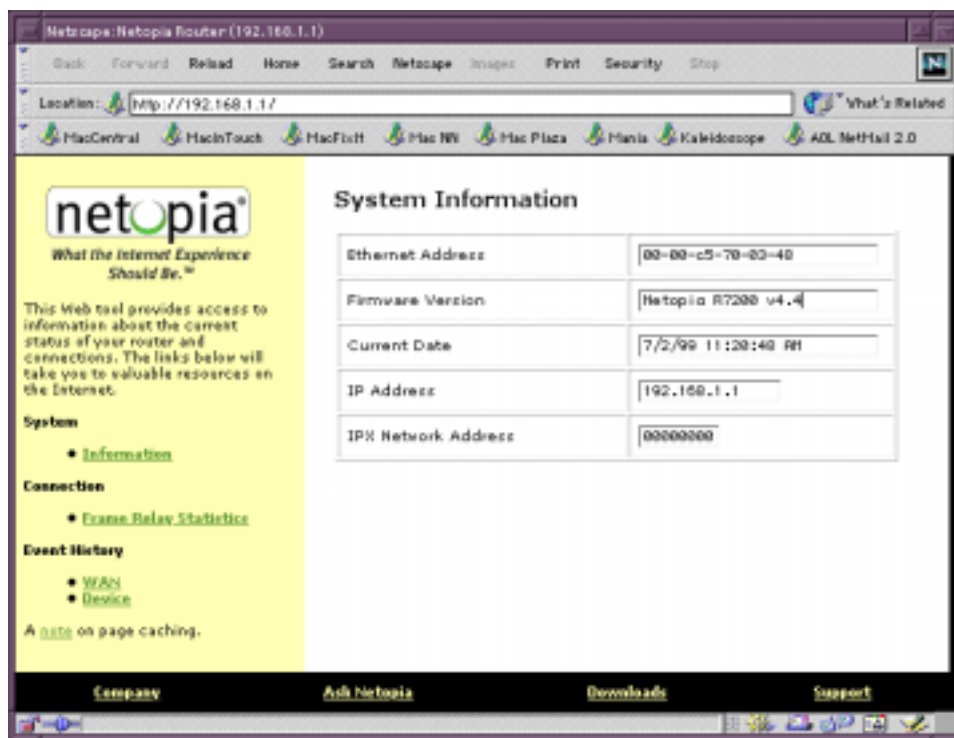

It displays useful general information about your router:

**Ethernet Address:** The router's hardware or MAC address

**Firmware Version:** The router's model number and current firmware revision level

**Current Date:** The current date and time, as you have configured them

**IP Address:** The router's internal IP address

**IPX Network Address:** The router's IPX network address, if you have it enabled and are on an IPX network

The display contains two frames, a navigation frame on the left and the information and configuration page on the right.

The left frame permits you to navigate to:

- System
  - Information: displays the router's hardware (MAC) address, the model number and firmware version currently installed, the current date and time, the router's IP address, and the IPX address, if any.
- Event History
  - ["WAN Event History page" on page 13-18](#): displays the most recent events that the router reports for your WAN connections.
  - ["Device Event History page" on page 13-19](#): displays the most recent events that the router reports of its own internal activity.

If you click any link in the left frame, that page is displayed in the right frame.

## *Event History pages*

The Netopia R7200 records certain relevant occurrences in event histories. Event histories are useful for diagnosing problems because they list what happened before, during, and after a problem occurs. You can view two different event histories: one for the router's system and one for the WAN. The Netopia R7200's built-in battery backup prevents loss of event history from a shutdown or reset.

The router's event histories are structured to display the most recent events first and to make it easy to distinguish error messages from informational messages. Error messages are prefixed with an asterisk. Both the WAN Event History and Device Event History pages retain records of up to 128 of the most recent events.

The screenshot shows a Netscape browser window titled "Netscape: Netopia Router (192.168.1.1)". The address bar shows "http://192.168.1.1/PmEvtLog". The main content area is titled "WAN Event History" and contains the following text:

Below is a list of the 23 most recently logged WAN Events.

Click here to [update this page](#).

03/01/99	10:59:47	--Device restarted--
03/01/99	09:59:39	--Device restarted--
04/27/99	10:00:34	--Device restarted--
04/27/99	09:59:04	--Device restarted--
04/27/99	09:58:07	--Device restarted--
04/27/99	09:51:42	--Device restarted--
04/26/99	13:47:37	--Device restarted--
04/26/99	10:37:00	Link 1 down: Remote clearing, cause: 41, diag: 12
04/26/99	10:37:00	Issued Clear Response to DN: (not supplied)
04/26/99	10:37:00	Received Clear Ind. from DN: (not supplied), Cause: 41
04/26/99	10:36:50	Issued Speech Setup Request from our DN: (not supplied)
04/26/99	10:36:50	--Device restarted--
04/26/99	10:33:09	--Device restarted--
04/26/99	09:15:19	--Device restarted--
04/23/99	14:59:09	T1: Loopback terminated
04/23/99	14:55:23	T1: Sending remote (payload) loopback
04/23/99	14:30:48	--Device restarted--
04/23/99	14:12:29	--Device restarted--
04/23/99	13:59:57	--Device restarted--
04/23/99	13:19:02	--Device restarted--
04/23/99	11:16:01	--Device restarted--
04/23/99	11:04:27	--Device restarted--
04/23/99	11:03:10	--Device restarted--

The sidebar on the left contains the following sections:

- System**
  - Information
- Connection**
  - Status
  - Connect/Disconnect
- Accounting**
  - Router Objects
  - Connection Objects
- Event History**
  - WAN
  - Device

At the bottom of the sidebar, it says "A note on page caching."

The footer of the browser window contains the following links: [Company](#), [Ask Netopia](#), [Downloads](#), and [Support](#).

You can refresh the WAN Event History log by clicking the **update this page** link.

## Device Event History page

The screenshot shows a Netscape browser window displaying the 'Device Event History' page of a Netopia Router. The browser's address bar shows the URL 'http://192.168.1.1/04+EvLog'. The page features a yellow sidebar with the Netopia logo and navigation links. The main content area is titled 'Device Event History' and contains a list of 41 most recently logged device events. Each event entry includes a date and time, a status indicator (e.g., 'BOOT: Warm start'), and a description of the event (e.g., 'IP address server initialization complete'). A link to 'update this page' is provided at the top of the event list.

**netopia**  
What the Internet Experience Should Be.™

This Web tool provides access to information about the current status of your router and connects. The links below will take you to valuable resources on the Internet.

**System**

- [Information](#)

**Connection**

- [Status](#)
- [Connect/Disconnect](#)

**Accounting**

- [Router/Router](#)
- [Connection/Router](#)

**Event History**

- [Watch](#)
- [Delete](#)

A [link](#) on page caching.

### Device Event History

Below is a list of the 41 most recently logged Device Events.

Click here to [update this page](#).

03/01/70	10:59:47	IP address server initialization complete
03/01/70	10:59:47	---BOOT: Warm start v4.3.3a1---
03/01/70	10:59:21	090222 octets read
03/01/70	09:58:38	IP address server initialization complete
03/01/70	09:58:38	---BOOT: Cold start v4.3.3a5---
02/28/70	16:33:34	Telnet connection down, address 192.168.1.104
04/27/99	10:00:43	Telnet connection up, address 192.168.1.104
04/27/99	10:00:34	IP address server initialization complete
04/27/99	10:00:34	---BOOT: Cold start v4.3.3a5---
04/27/99	09:56:36	Telnet connection up, address 192.168.1.104
04/27/99	09:56:04	IP address server initialization complete
04/27/99	09:56:04	---BOOT: Warm start v4.3.3a9---
04/27/99	09:55:31	Telnet connection up, address 192.168.1.104
04/27/99	09:55:07	IP address server initialization complete
04/27/99	09:55:07	---BOOT: Warm start v4.3.3a5---
04/27/99	09:52:00	Telnet connection up, address 192.168.1.104
04/27/99	09:51:42	IP address server initialization complete
04/27/99	09:51:42	---BOOT: Cold start v4.3.3a9---
04/26/99	13:47:37	IP address server initialization complete
04/26/99	13:47:37	---BOOT: Cold start v4.3.3a9---
04/26/99	10:36:50	IP address server initialization complete
04/26/99	10:36:50	---BOOT: Cold start v4.3.3a9---
04/26/99	10:33:05	IP address server initialization complete
04/26/99	10:33:05	---BOOT: Warm start v4.3.3a9---
04/26/99	09:15:19	IP address server initialization complete

Summary    Ask Netopia    Downloads    Support

You can refresh the Device Event History log by clicking the **update this page** link.



## Chapter 14

# Security

The Netopia R7200 provides a number of security features to help protect its configuration screens and your local network from unauthorized access. Although these features are optional, it is strongly recommended that you use them.

This section covers the following topics:

- “Suggested security measures” on page 14-1
- “User accounts” on page 14-1
- “Dial-in console access” on page 14-3
- “Enable SmartStart/SmartView/Web server” on page 14-4
- “Telnet access” on page 14-4
- “About filters and filter sets” on page 14-4
- “Working with IP filters and filter sets” on page 14-12
- “IPX filters” on page 14-21.
- “Firewall tutorial” on page 14-29

---

### *Suggested security measures*

In addition to setting up user accounts, Telnet access, and filters (all of which are covered later in this chapter), there are other actions you can take to make the Netopia R7200 and your network more secure:

- Change the SNMP community strings (or passwords). The default community strings are universal and could easily be known to a potential intruder.
- Set the answer profile so it must match incoming calls to a connection profile.
- Leave the Enable Dial-in Console Access option set to No.
- When using AURP, accept connections only from configured partners.
- Configure the Netopia R7200 through the serial console port to ensure that your communications cannot be intercepted.

---

### *User accounts*

When you first set up and configure the Netopia R7200, no passwords are required to access the configuration screens. Anyone could tamper with the router’s configuration by simply connecting it to a console.

However, by adding user accounts, you can protect the most sensitive screens from unauthorized access. User accounts are composed of name/password combinations that can be given to authorized users.

### Caution!

You are strongly encouraged to add protection to the configuration screens. Unprotected screens could allow an unauthorized user to compromise the operation of your entire network.

Once user accounts are created, users who attempt to access protected screens will be challenged. Users who enter an incorrect name or password are returned to a screen requesting a name/password combination to access the Main Menu.

To set up user accounts, in the System Configuration screen select **Security** and press Return. The Security Options screen appears.

```
Security Options

Enable Dial-in Console Access:           Yes
Enable SmartStart/SmartView/Web Server:  Yes
Enable Telnet Console Access:           Yes
Enable Telnet Access to SNMP Screens:    Yes

Show Users...
Add User...
Delete User...

Password for This Screen (11 chars max):

Return/Enter accepts * Tab toggles * ESC cancels.
Set up configuration access options here.
```

### Protecting the Security Options screen

The first screen you should protect is the Security Options screen, because it controls access to the configuration screens. Access to the Security Options screen can be protected with a password.

Select **Password for This Screen** in the Security Options screen and enter a password. Make sure this password is secure and is different from any of the user account passwords.

### Protecting the configuration screens

You can protect the configuration screens with user accounts. You can administer the accounts from the Security Options screen. You can create up to four accounts.

To display a view-only list of user accounts, select **Show Users** in the Security Options screen.



To add a new user account, select **Add User** in the Security Options screen and press Return. The Add Name With Write Access screen appears.

Add Name With Write Access

Enter Name:

Enter Password (11 characters max):

ADD NAME/PASSWORD NOW                      CANCEL

Follow these steps to configure the new account:

1. Select **Enter Name** and enter a descriptive name (for example, the user's first name).
2. Select **Enter Password** and enter a password.
3. To accept the new name/password combination, select **ADD NAME/PASSWORD NOW** and press Return. To exit the Add Name With Write Access screen without saving the new account, select **CANCEL**. You are returned to the Security Options screen.

To delete a user account, select **Delete User** to display a list of accounts. Select an account from the list and press Return to delete it. To exit the list without deleting the selected account, press Escape.

---

## *Dial-in console access*

Remote modem terminal emulator setups can dial in to the modem line and establish a remote console session, even though they are not using PPP. This allows Netopia, Inc.'s Up and Running, Guaranteed! department or other administrator with the appropriate security to remotely configure your router for you.

- To prevent any remote caller from establishing a remote session, set the option **Enable Dial-in Console Access** set to **No**.
- To allow access for Up and Running, Guaranteed! with the default name and password in place, toggle this option to **Yes**.

## *Enable SmartStart/SmartView/Web server*

You may want to restrict access to the Web-based screens to prevent inadvertent switching or connecting and disconnecting of connection profiles. Since SmartStart can be used to reconfigure the router, you may want to block inadvertent damage resulting from unauthorized use of SmartStart. To prevent access to these features toggle this option to **No**.

---

## *Telnet access*

Telnet is a TCP/IP service that allows remote terminals to access hosts on an IP network. The Netopia R7200 supports Telnet access to its configuration screens.

### **Caution!**

You should consider password-protecting or restricting Telnet access to the Netopia R7200 if you suspect there is a chance of tampering.

To password-protect the configuration screens, select Easy Setup from the Main Menu, and go to the Easy Setup Security Configuration screen. By entering a name and password pair in this screen, all access via serial, Telnet, SNMP, and Web server will be password-protected.

To restrict Telnet access, select **Security** in the Advanced Configuration menu. The Security Options screen will appear. There are two levels of Telnet restriction available:

- To restrict Telnet access to the SNMP screens, select **Enable Telnet Access to SNMP Screens** and toggle it to **No**. (See ["SNMP traps" on page 13-14.](#))
- To restrict Telnet access to all of the configuration screens, select **Enable Telnet Console Access** and toggle it to **No**.

---

## *About filters and filter sets*

Security should be a high priority for anyone administering a network connected to the Internet. Using packet filters to control network communications can greatly improve your network's security.

The Netopia R7200's packet filters are designed to provide security for the Internet connections made to and from your network. You can customize the router's filter sets for a variety of packet filtering applications. Typically, you use filters to selectively admit or refuse TCP/IP connections from certain remote networks and specific hosts. You will also use filters to screen particular types of connections. This is commonly called firewalling your network.

Before creating filter sets, you should read the next few sections to learn more about how these powerful security tools work.

## *What's a filter and what's a filter set?*

A filter is a rule that lets you specify what sort of data can flow in and out of your network. A particular filter can be either an input filter—one that is used on data (packets) coming in to your network from the Internet—or an output filter—one that is used on data (packets) going out from your network to the Internet.

A filter set is a group of filters that work together to check incoming or outgoing data. A filter set can consist of a combination of input and output filters.

## *How filter sets work*

A filter set acts like a team of customs inspectors. Each filter is an inspector through which incoming and outgoing packages must pass. The inspectors work as a team, but each inspects every package individually.

Each inspector has a specific task. One inspector's task may be to examine the destination address of all outgoing packages. That inspector looks for a certain destination—which could be as specific as a street address or as broad as an entire country—and checks each package's destination address to see if it matches that destination.

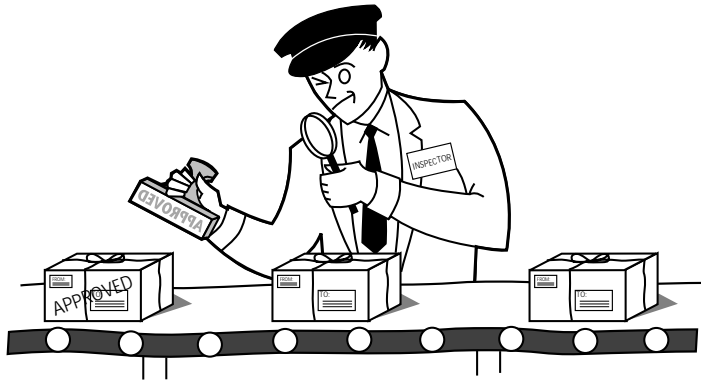

*A filter inspects data packets like a customs inspector scrutinizing packages.*

## *Filter priority*

Continuing the customs inspectors analogy, imagine the inspectors lined up to examine a package. If the package matches the first inspector's criteria, the package is either rejected or passed on to its destination, depending on the first inspector's particular orders. In this case, the package is never seen by the remaining inspectors.

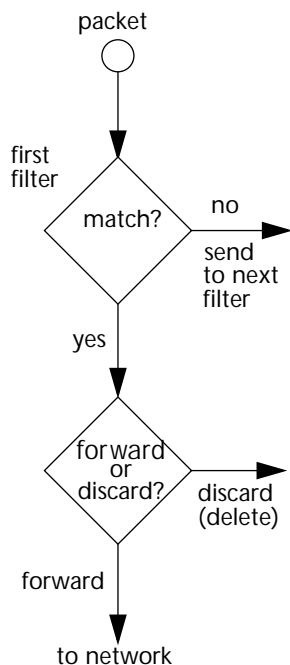

If the package does not match the first inspector's criteria, it goes to the second inspector, and so on. You can see that the order of the inspectors in the line is very important.

For example, let's say the first inspector's orders are to send along all packages that come from Rome, and the second inspector's orders are to reject all packages that come from France. If a package arrives from Rome, the first inspector sends it along without allowing the second inspector to see it. A package from Paris is ignored by the first inspector, rejected by the second inspector, and never seen by the others. A package from London is ignored by the first two inspectors, so it's seen by the third inspector.

In the same way, filter sets apply their filters in a particular order. The first filter applied can forward or discard a packet before that packet ever reaches any of the other filters. If the first filter can neither forward nor discard the packet (because it cannot match any criteria), the second filter has a chance to forward or reject it, and so on. Because of this hierarchical structure, each filter is said to have a priority. The first filter has the highest priority, and the last filter has the lowest priority.

### *How individual filters work*

As described above, a filter applies criteria to an IP packet and then takes one of three actions:

- Forwards the packet to the local or remote network
- Blocks (discards) the packet
- Ignores the packet

A filter forwards or blocks a packet only if it finds a match after applying its criteria. When no match occurs, the filter ignores the packet.

### A filtering rule

The criteria are based on information contained in the packets. A filter is simply a rule that prescribes certain actions based on certain conditions. For example, the following rule qualifies as a filter:

Block all Telnet attempts that originate from the remote host 199.211.211.17.

This rule applies to Telnet packets that come from a host with the IP address 199.211.211.17. If a match occurs, the packet is blocked.

Here is what this rule looks like when implemented as a filter on the Netopia R7200:

+-#--	Source IP Addr--	Dest IP Addr----	Proto--	Src.Port--	D.Port--	On?--	Fwd--
1	199.211.211.17	0.0.0.0	TCP	23		Yes	No

To understand this particular filter, look at the parts of a filter.

### Parts of a filter

A filter consists of criteria based on packet attributes. A typical filter can match a packet on any one of the following attributes:

- The source IP address (where the packet was sent from)
- The destination IP address (where the packet is going)
- The type of higher-layer Internet protocol the packet is carrying, such as TCP or UDP

### Port numbers

A filter can also match a packet's port number attributes, but only if the filter's protocol type is set to TCP or UDP, since only those protocols use port numbers. The filter can be configured to match the following:

- The source port number (the port on the sending host that originated the packet)
- The destination port number (the port on the receiving host that the packet is destined for)

By matching on a port number, a filter can be applied to selected TCP or UDP services, such as Telnet, FTP, and World Wide Web. The following tables show a few common services and their associated port numbers:

Internet service	TCP port	Internet service	TCP port
FTP	20/21	Finger	79
Telnet	23	World Wide Web	80
SMTP (mail)	25	News	144
Gopher	70	rlogin	513

Internet service	UDP port	Internet service	UDP port
Who Is	43	AppleTalk Routing Maintenance (at-rtmp)	202
World Wide Web	80	AppleTalk Name Binding (at-nbp)	202
SNMP	161	AURP (AppleTalk)	387
TFTP	69	who	513

### *Port number comparisons*

A filter can also use a comparison option to evaluate a packet's source or destination port number. The comparison options are:

**No Compare:** No comparison of the port number specified in the filter with the packet's port number.

**Not Equal To:** For the filter to match, the packet's port number cannot equal the port number specified in the filter.

**Less Than:** For the filter to match, the packet's port number must be less than the port number specified in the filter.

**Less Than or Equal:** For the filter to match, the packet's port number must be less than or equal to the port number specified in the filter.

**Equal:** For the filter to match, the packet's port number must equal the port number specified in the filter.

**Greater Than:** For the filter to match, the packet's port number must be greater than the port number specified in the filter.

**Greater Than or Equal:** For the filter to match, the packet's port number must be greater than or equal to the port number specified in the filter.

### *Other filter attributes*

There are three other attributes to each filter:

- The filter's order (i.e., priority) in the filter set
- Whether the filter is currently active
- Whether the filter is set to forward packets or to block (discard) packets

## Putting the parts together

When you display a filter set, its filters are displayed as rows in a table:

```

+---#---Source IP Addr---Dest IP Addr-----Proto-Src.Port-D.Port---On?-Fwd--+
+-----+-----+-----+-----+-----+-----+-----+-----+
 1 192.211.211.17 0.0.0.0          TCP    0      23      Yes No
 2 0.0.0.0         0.0.0.0          TCP    NC     =6000   Yes No
 3 0.0.0.0         0.0.0.0          ICMP   --     --      Yes Yes
 4 0.0.0.0         0.0.0.0          TCP    NC     >1023   Yes Yes
 5 0.0.0.0         0.0.0.0          UDP    NC     >1023   Yes Yes

```

The table's columns correspond to each filter's attributes:

**#:** The filter's priority in the set. Filter number 1, with the highest priority, is first in the table.

**Source IP Addr:** The packet source IP address to match.

**Dest IP Addr:** The packet destination IP address to match.

**Proto:** The protocol to match. This can be entered as a number (see the table below) or as TCP or UDP if those protocols are used.

Protocol	Number to use	Full name
N/A	0	Ignores protocol type
ICMP	1	Internet Control Message Protocol
TCP	6	Transmission Control Protocol
UDP	17	User Datagram Protocol

**Src. Port:** The source port to match. This is the port on the sending host that originated the packet.

**D. Port:** The destination port to match. This is the port on the receiving host for which the packet is intended.

**On?:** Displays **Yes** when the filter is in effect or **No** when it is not.

**Fwd:** Shows whether the filter forwards (**Yes**) a packet or discards (**No**) it when there's a match.

### Filtering example #1

Returning to our filtering rule example from above (see [page 14-7](#)), look at how a rule is translated into a filter. Start with the rule, then fill in the filter's attributes:

1. The rule you want to implement as a filter is:  
Block all Telnet attempts that originate from the remote host 199.211.211.17.
2. The host 199.211.211.17 is the source of the Telnet packets you want to block, while the destination address is any IP address. How these IP addresses are masked determines what the final match will be, although the mask is not displayed in the table that displays the filter sets (you set it when you create the filter). In fact, since the mask for the destination IP address is 0.0.0.0, the address for Dest IP Addr could have been anything. The mask for Source IP Addr must be 255.255.255.255 since an exact match is desired.
  - Source IP Addr = 199.211.211.17
  - Source IP address mask = 255.255.255.255
  - Dest IP Addr = 0.0.0.0
  - Destination IP address mask = 0.0.0.0

**Note:** To learn about IP addresses and masks, see [Appendix B, "Understanding IP Addressing."](#)
3. Using the tables on [page 14-7](#), find the destination port and protocol numbers (the *local* Telnet port):
  - Proto = TCP (or 6)
  - D. Port = 23
4. The filter should be enabled and instructed to block the Telnet packets containing the source address shown in step 2:
  - On? = Yes
  - Fwd = No

This four-step process is how we produced the following filter from the original rule:

+ #	Source IP Addr	Dest IP Addr	Proto	Src. Port	D. Port	On?	Fwd	+
1	192.211.211.17	0.0.0.0	TCP	0	23	Yes	No	

### Filtering example #2

Suppose a filter is configured to block all incoming IP packets with the source IP address of 200.233.14.0, regardless of the type of connection or its destination. The filter would look like this:



+	#	Source IP Addr	Dest IP Addr	Proto	Src.Port	D.Port	On?	Fwd	+
	1	200.233.14.0	0.0.0.0		0		Yes	No	

This filter blocks any packets coming from a remote network with the IP network address 200.233.14.0. The 0 at the end of the address signifies *any* host on the class C IP network 200.233.14.0. If, for example, the filter is applied to a packet with the source IP address 200.233.14.5, it will block it.

In this case, the mask, which does not appear in the table, must be set to 255.255.255.0. This way, all packets with a source address of 200.233.14.x will be matched correctly, no matter what the final address byte is.

**Note:** The protocol attribute for this filter is 0 by default. This tells the filter to ignore the IP protocol or type of IP packet.

## Design guidelines

Careful thought must go into designing a new filter set. You should consider the following guidelines:

- Be sure the filter set's overall purpose is clear from the beginning. A vague purpose can lead to a faulty set, and that can actually make your network *less* secure.
- Be sure each individual filter's purpose is clear.
- Determine how filter priority will affect the set's actions. Test the set (on paper) by determining how the filters would respond to a number of different hypothetical packets.
- Consider the combined effect of the filters. If every filter in a set fails to match on a particular packet, the packet is:
  - Forwarded if all the filters are configured to discard (*not* forward)
  - Discarded if all the filters are configured to forward
  - Discarded if the set contains a combination of forward and discard filters

## Disadvantages of filters

Although using filter sets can greatly enhance network security, there are disadvantages:

- Filters are complex. Combining them in filter sets introduces subtle interactions, increasing the likelihood of implementation errors.
- Enabling a large number of filters can have a negative impact on performance. Processing of packets will take longer if they have to go through many checkpoints.
- Too much reliance on packet filters can cause too little reliance on other security methods. Filter sets are *not* a substitute for password protection, effective safeguarding of passwords, caller ID, the "must match" option in the answer profile, PAP or CHAP in connection profiles, callback, and general awareness of how your network may be vulnerable.

### An approach to using filters

The ultimate goal of network security is to prevent unauthorized access to the network without compromising authorized access. Using filter sets is part of reaching that goal.

Each filter set you design will be based on one of the following approaches:

- That which is not expressly prohibited is permitted.
- That which is not expressly permitted is prohibited.

It is strongly recommended that you take the latter, and safer, approach to all of your filter set designs.

---

### Working with IP filters and filter sets

This section covers IP filters and filter sets. For working with IPX filters and filter sets, see ["IPX filters"](#) on page 14-21.

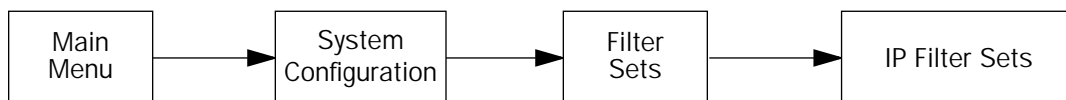

To work with filters and filter sets, begin by accessing the filter set screens.

**Note:** Make sure you understand how filters work before attempting to use them. Read the section ["About filters and filter sets,"](#) beginning on page 14-4.

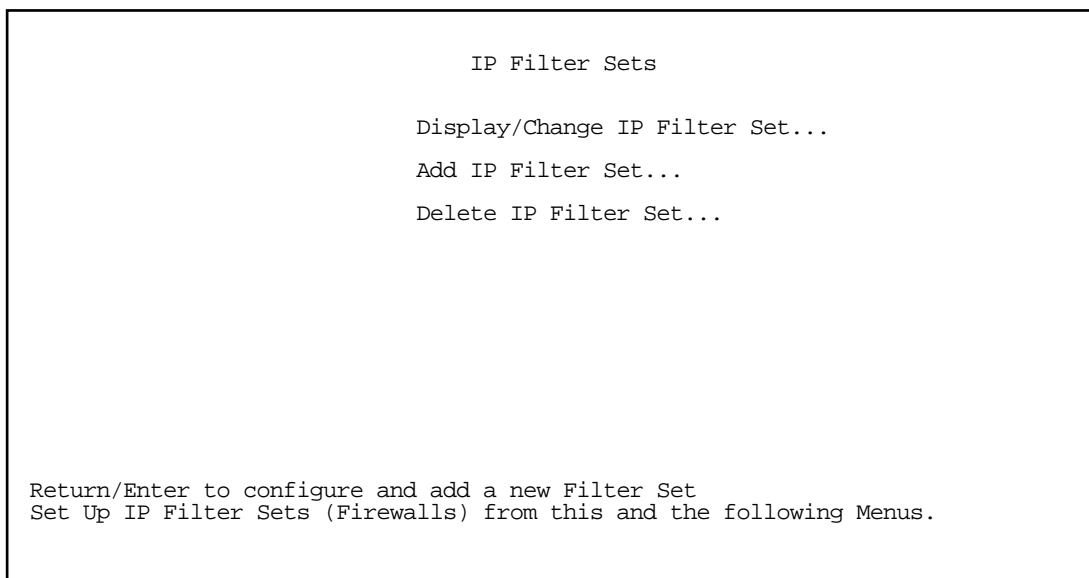

The procedure for creating and maintaining filter sets is as follows:

1. Add a new filter set.
2. Create the filters for the new filter set.

3. View, change, or delete individual filters and filter sets.

The sections below explain how to execute these steps.

### *Adding a filter set*

You can create up to eight different custom filter sets. Each filter set can contain up to 16 output filters and up to 16 input filters.

To add a new filter set, select **Add IP Filter Set** in the IP Filter Sets screen and press Return. The Add Filter Set screen appears.

**Note:** There are two groups of items in the Add IP Filter Set screen, one for input filters and one for output filters. The two groups work in essentially the same way, as you'll see below.

Add IP Filter Set

Filter Set Name: Filter Set 3

Display/Change Input Filter...

Add Input Filter...

Delete Input Filter...

Display/Change Output Filter...

Add Output Filter...

Delete Output Filter...

ADD FILTER SET CANCEL

Configure the Filter Set name and its associated Filters.

### *Naming a new filter set*

All new filter sets have a default name. The first filter set you add will be called Filter Set 1, the next filter will be Filter Set 2, and so on.

To give a new filter set a different name, select **Filter Set Name** and enter a new name for the filter set.

To save the filter set, select **ADD FILTER SET**. The saved filter set is empty (contains no filters), but you can return to it later to add filters (see ["Modifying filter sets" on page 14-17](#)). Or you can add filters to your new set before saving it (see ["Adding filters to a filter set" on page 14-14](#)).

To leave the Add Filter Set screen without saving the new filter set select **CANCEL**. You are returned to the IP Filter Sets screen.

*Input and output filters—source and destination*

There are two kinds of filters you can add to a filter set: input and output. Input filters check packets received from the Internet, destined for your network. Output filters check packets transmitted from your network to the Internet.

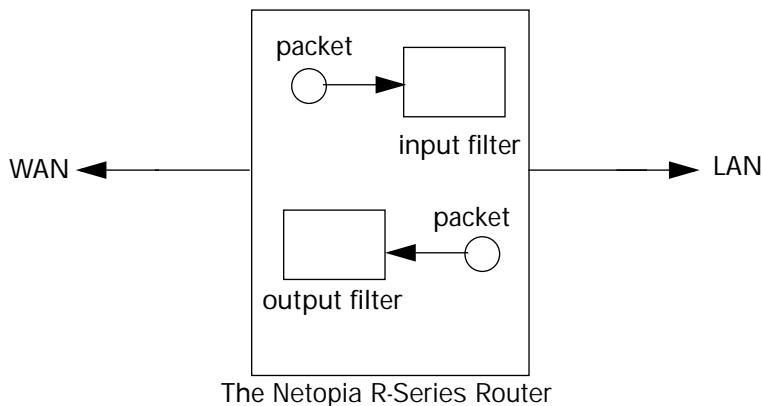

*Packets in the Netopia R7200 pass through an input filter if they originate in the WAN and through an output filter if they're being sent out to the WAN.*

The process for adding input and output filters is exactly the same. The main difference between the two involves their reference to source and destination. From the perspective of an input filter, your local network is the destination of the packets it checks, and the remote network is their source. From the perspective of an output filter, your local network is the source of the packets, and the remote network is their destination.

Type of filter	Source means	Destination means
Input filter	The remote network	The local network
Output filter	The local network	The remote network

*Adding filters to a filter set*

In this section you'll learn how to add an input filter to a filter set. Adding an output filter works exactly the same way, providing you keep the different source and destination perspectives in mind.

To add an input filter, select **Add Input Filter** in the Add IP Filter Set screen. The Add Filter screen appears. (To add an output filter, select **Add Output Filter**.)

Add Filter	
Enabled:	No
Forward:	No
Source IP Address:	0.0.0.0
Source IP Address Mask:	0.0.0.0
Dest. IP Address:	0.0.0.0
Dest. IP Address Mask:	0.0.0.0
Protocol Type:	0
Source Port Compare...	No Compare
Source Port ID:	0
Dest. Port Compare...	No Compare
Dest. Port ID:	0
ADD THIS FILTER NOW	CANCEL

Enter the IP specific information for this filter.

1. To make the filter active in the filter set, select **Enabled** and toggle it to **Yes**. If **Enabled** is toggled to **No**, the filter can still exist in the filter set, but it will have no effect.
  2. If you want the filter to forward packets that match its criteria to the destination IP address, select **Forward** and toggle it to **Yes**. If **Forward** is toggled to **No**, packets matching the filter's criteria will be discarded.
  3. Select **Source IP Address** and enter the source IP address this filter will match on. You can enter a subnet or a host address.
  4. Select **Source IP Address Mask** and enter a mask for the source IP address. This allows you to further modify the way the filter will match on the source address. Enter 0.0.0.0 to force the filter to match on all source IP addresses, or enter 255.255.255.255 to match the source IP address exclusively.
  5. Select **Dest. IP Address** and enter the destination IP address this filter will match on. You can enter a subnet or a host address.
  6. Select **Dest. IP Address Mask** and enter a mask for the destination IP address. This allows you to further modify the way the filter will match on the destination address. Enter 0.0.0.0 to force the filter to match on all destination IP addresses.
  7. Select **Protocol Type** and enter **ICMP**, **TCP**, **UDP**, **Any**, or the number of another IP transport protocol (see the table on [page 14-9](#)).
- Note:** If Protocol Type is set to TCP or UDP, the settings for port comparison that you configure in steps 8 and 9 will appear. These settings only take effect if the Protocol Type is TCP or UDP.
8. Select **Source Port Compare** and choose a comparison method for the filter to use on a packet's source port number. Then select **Source Port ID** and enter the actual source port number to match on (see the table on [page 14-7](#)).
  9. Select **Dest. Port Compare** and choose a comparison method for the filter to use on a packet's destination port number. Then select **Dest. Port ID** and enter the actual destination port number to match on (see the table on [page 14-7](#)).

## 14-16 User's Reference Guide

- When you are finished configuring the filter, select **ADD THIS FILTER NOW** to save the filter in the filter set. Select **CANCEL** to discard the filter and return to the Add IP Filter Set screen.

### Viewing filters

To display a view-only table of input or output filters, select **Display/Change Input Filter** or **Display/Change Output Filter** in the Add IP Filter Set screen.

### Modifying filters

To modify a filter, select **Display/Change Input Filter** or **Display/Change Output Filter** in the Add IP Filter Set screen to display a table of filters.

Select a filter from the table and press Return. The Change Filter screen appears. The parameters in this screen are set in the same way as the ones in the Add Filter screen (see ["Adding filters to a filter set" on page 14-14](#)).

Change Filter

Enabled:	No
Forward:	No
Source IP Address:	0.0.0.0
Source IP Address Mask:	0.0.0.0
Dest. IP Address:	0.0.0.0
Dest. IP Address Mask:	0.0.0.0
Protocol Type:	0
Source Port Compare...	No Compare
Source Port ID:	0
Dest. Port Compare...	No Compare
Dest. Port ID:	0

Enter the IP specific information for this filter.

### Deleting filters

To delete a filter, select **Delete Input Filter** or **Delete Output Filter** in the Add IP Filter Set screen to display a table of filters.

Select the filter from the table and press Return to delete it. Press Escape to exit the table without deleting the filter.

### Viewing filter sets

To display a view-only list of filter sets, select **Display/Change IP Filter Set** in the IP Filter Sets screen.

## Modifying filter sets

To modify a filter set, select **Display/Change IP Filter Set** in the IP Filter Sets screen to display a list of filter sets.

Select a filter set from the list and press Return. The Change IP Filter Set screen appears. The items in this screen are the same as the ones in the Add Filter screen (see [“Adding filters to a filter set”](#) on page 14-14).

```

Change IP Filter Set

Filter Set Name:                Basic Firewall

Display/Change Input Filter...
Add Input Filter...
Delete Input Filter...

Display/Change Output Filter...
Add Output Filter...
Delete Output Filter...

```

## Deleting a filter set

**Note:** If you delete a filter set, all of the filters it contains are deleted as well. To reuse any of these filters in another set, before deleting the current filter set you'll have to note their configuration and then recreate them.

To delete a filter set, select **Delete IP Filter Set** in the IP Filter Sets screen to display a list of filter sets.

Select a filter set from the list and press Return to delete it. Press Escape to exit the list without deleting the filter set.

## A sample IP filter set

This section contains the settings for a filter set called Basic Firewall, which is part of the Netopia R7200's factory configuration.

Basic Firewall blocks undesirable traffic originating from the WAN (in most cases, the Internet), but forwards all traffic originating from the LAN. It follows the conservative "that which is not expressly permitted is prohibited" approach: unless an incoming packet expressly matches one of the constituent input filters, it will not be forwarded to the LAN.

The five input filters and one output filter that make up Basic Firewall are shown in the table below.

Setting	Input filter 1	Input filter 2	Input filter 3	Input filter 4	Input filter 5	Output filter 1
Enabled	Yes	Yes	Yes	Yes	Yes	Yes
Forward	No	No	Yes	Yes	Yes	Yes
Source IP address	0.0.0.0	0.0.0.0	0.0.0.0	0.0.0.0	0.0.0.0	0.0.0.0
Source IP address mask	0.0.0.0	0.0.0.0	0.0.0.0	0.0.0.0	0.0.0.0	0.0.0.0
Dest. IP address	0.0.0.0	0.0.0.0	0.0.0.0	0.0.0.0	0.0.0.0	0.0.0.0
Dest. IP address mask	0.0.0.0	0.0.0.0	0.0.0.0	0.0.0.0	0.0.0.0	0.0.0.0
Protocol type	TCP	TCP	ICMP	TCP	UDP	0
Source port comparison	No Compare	No Compare	N/A	No Compare	No Compare	N/A
Source port ID	0	0	N/A	0	0	N/A
Dest. port comparison	Equal	Equal	N/A	Greater Than	Greater Than	N/A
Dest. port ID	2000	6000	N/A	1023	1023	N/A

Basic Firewall's filters play the following roles.

**Input filters 1 and 2:** These block WAN-originated OpenWindows and X-Windows sessions. Service origination requests for these protocols use ports 2000 and 6000, respectively. Since these are greater than 1023, OpenWindows and X-Windows traffic would otherwise be allowed by input filter 4. Input filters 1 and 2 must precede input filter 4; otherwise they would have no effect since filter 4 would have already forwarded OpenWindows and X-Windows traffic.

**Input filter 3:** This filter explicitly forwards all WAN-originated ICMP traffic to permit devices on the WAN to ping devices on the LAN. Ping is an Internet service that is useful for diagnostic purposes.

**Input filters 4 and 5:** These filters forward all TCP and UDP traffic, respectively, when the destination port is greater than 1023. This type of traffic generally does not allow a remote host to connect to the LAN using one of the potentially intrusive Internet services, such as Telnet, FTP, and WWW.

**Output filter 1:** This filter forwards all outgoing traffic to make sure that no outgoing connections from the LAN are blocked.



Basic Firewall is suitable for a LAN containing only client hosts that want to access servers on the WAN, but not for a LAN containing servers providing services to clients on the WAN. Basic Firewall's general strategy is to explicitly forward WAN-originated TCP and UDP traffic to ports greater than 1023. Ports lower than 1024 are the service origination ports for various Internet services such as FTP, Telnet, and the World Wide Web (WWW).

A more complicated filter set would be required to provide WAN access to a LAN-based server. See the next section, "[Possible modifications](#)," for ways to allow remote hosts to use services provided by servers on the LAN.

### *Possible modifications*

You can modify the sample filter set Basic Firewall to allow incoming traffic using the examples below. These modifications are not intended to be combined. Each modification is to be the only one used with Basic Firewall.

The results of combining filter set modifications can be difficult to predict. It is recommended that you take special care if you are making more than one modification to the sample filter set.

**Trusted host.** To allow unlimited access by a trusted remote host with the IP address a.b.c.d (corresponding to a numbered IP address such as 163.176.8.243), insert the following input filter ahead of the current input filter 1:

- Enabled: Yes
- Forward: Yes
- Source IP Address: a.b.c.d
- Source IP Address Mask: 255.255.255.255
- Dest. IP Address: 0.0.0.0
- Dest. IP Address Mask: 0.0.0.0
- Protocol Type: 0

**Trusted subnet.** To allow unlimited access by a trusted remote subnet with subnet address a.b.c.d (corresponding to a numbered IP address such as 163.176.8.0) and subnet mask e.f.g.h (corresponding to a numbered IP mask such as 255.255.255.0), insert the following input filter ahead of the current input filter 1:

- Enabled: Yes
- Forward: Yes
- Source IP Address: a.b.c.d
- Source IP Address Mask: e.f.g.h
- Dest. IP Address: 0.0.0.0
- Dest. IP Address Mask: 0.0.0.0
- Protocol Type: 0

**FTP sessions.** To allow WAN-originated FTP sessions to a LAN-based FTP server with the IP address a.b.c.d (corresponding to a numbered IP address such as 163.176.8.243), insert the following input filter ahead of the current input filter 1:

- Enabled: Yes
- Forward: Yes
- Source IP Address: 0.0.0.0
- Source IP Address Mask: 0.0.0.0
- Dest. IP Address: a.b.c.d
- Dest. IP Address Mask: 255.255.255.255
- Protocol Type: TCP
- Source Port Comparison: No Compare
- Source Port ID: 0
- Dest. Port Comparison: Equal
- Dest. Port ID: 21

**Note:** A similar filter could be used to permit Telnet or WWW access. Set the Dest. Port ID to 23 for Telnet or to 80 for WWW.

**AURP tunnel.** To allow an AURP tunnel between a remote AURP router with the IP address a.b.c.d (corresponding to a numbered IP address such as 163.176.8.243) and a local AURP router (including the Netopia R7200 itself), insert the following input filter ahead of the current input filter 1:

- Enabled: Yes
- Forward: Yes
- Source IP Address: a.b.c.d
- Source IP Address Mask: 255.255.255.255
- Dest. IP Address: 0.0.0.0
- Dest. IP Address Mask: 0.0.0.0
- Protocol Type: UDP
- Source Port Comparison: Equal
- Source Port ID: 387
- Dest. Port Comparison: Equal
- Dest. Port ID: 387

## IPX filters

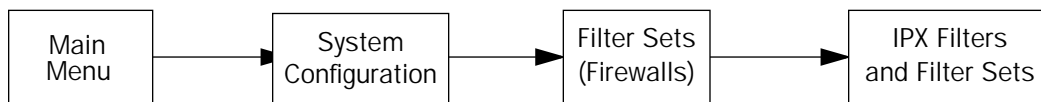

IPX packet filters work very similarly to IP packet filters. They filter data traffic coming from or going to remote IPX networks. IPX filters can be set up to forward or discard IPX packets based on a number of user-defined criteria. Like IP filters, IPX filters must be grouped in sets that are applied to the answer profile or to connection profiles.

IPX SAP filters are used for filtering server entries not required to pass over the WAN links. When connecting to a large IPX network via dial-up connection, the transfer of large numbers of SAP entries can consume significant bandwidth on the WAN link.

**Note:** Using SAP filtering to prevent a server from being advertised does not provide security against that server being accessed—IPX packet filtering must be used for that purpose.

Setting up and using IPX filter sets is a four-step process:

1. Create the filters to use.
2. Create the filter sets to use.
3. Add filters to the filter sets.
4. Attach the filter sets to the answer profile or to connection profiles.

You can configure IPX filters and set up IPX filter sets from the IPX Filters and Filter Sets screen.

IPX Filters and Filter Sets

Display/Change IPX Packet Filters...  
 Add IPX Packet Filter...  
 Delete IPX Packet Filter...

Display/Change IPX Packet Filter Sets...  
 Add IPX Packet Filter Set...  
 Delete IPX Packet Filter Set...

Display/Change IPX Sap Filters...  
 Add IPX Sap Filter...  
 Delete IPX Sap Filter...

Display/Change IPX Sap Filter Sets...  
 Add IPX Sap Filter Set...  
 Delete IPX Sap Filter Set...

Define your filters 1st. IPX Filter Sets refer to, but don't contain, filters.

The items in the IPX Filters and Filter Sets screen are grouped into four areas:

- IPX packet filters
- IPX packet filter sets
- IPX SAP filters
- IPX SAP filter sets

The following sections explain the items in each of these areas.

### *IPX packet filters*

For each IPX packet filter, you can configure a set of parameters to match on the source or destination attributes of IPX data packets coming from or going to the WAN.

#### *Viewing and modifying packet filters*

To display a view-only table of IPX packet filters, select **Display/Change IPX Packet Filters** in the IPX Filters and Filter Sets screen.

To modify any of the filters in the table, select the desired filter and press Return to go to the Change Packet Filter screen. The parameters in this screen are the same as the ones in the Add Packet Filter screen (see the next section).

#### *Adding a packet filter*

To add a new IPX packet filter, select **Add IPX Packet Filter** in the IPX Filters and Filter Sets screen and press Return. The Add Packet Filter screen appears.

```

                                Add Packet Filter

Filter Name:                      IPX Filter 1
Source Network:                   00000000
Source Node Address:              000000000000
Source Socket:                    0000
Destination Network:              00000000
Destination Node Address:         000000000000
Destination Socket:               0000

                                ADD FILTER NOW                                CANCEL

Configure a new IPX Packet Filter. Finished?  ADD or CANCEL to exit.
```

By default, the filter's socket numbers and network and node addresses are null (all zeros). This sets the filter to match on any IPX data packet. Configure the filter using criteria that meet your security needs.

1. Select **Filter Name** and enter a descriptive name for the filter.
2. To specify a source network for the filter to match on, select **Source Network** and enter an IPX network address.
3. To specify a source node for the filter to match on, select **Source Node Address** and enter an IPX node address.
4. To specify a source socket for the filter to match on, select **Source Socket** and enter an IPX source socket number.
5. To specify a destination network for the filter to match on, select **Destination Network** and enter an IPX network address.
6. To specify a destination node for the filter to match on, select **Destination Node Address** and enter an IPX node address.
7. To specify a destination socket for the filter to match on, select **Destination Socket** and enter an IPX destination socket number.
8. Select **ADD FILTER NOW** to save the current filter. Select **CANCEL** to exit the Add Packet Filter screen without saving the new filter.

### *Deleting a packet filter*

To delete a packet filter, select **Delete IPX Packet Filter** in the IPX Filters and Filter Sets screen to display a table of filters. Select a filter from the table and press Return to delete it. Press the Escape key to exit the table without deleting the filter.

### *IPX packet filter sets*

Before the individual filters can be used, IPX packet filters must be grouped into sets. A filter can be part of more than one filter set.

### *Viewing and modifying packet filter sets*

To display a table of IPX packet filter sets, select **Display/Change IPX Packet Filter Sets** in the IPX Filters and Filter Sets screen.

To modify any of the filter sets in the list, select the desired filter set and press Return to go to the Change Packet Filter Set screen. The parameters in this screen are the same as the ones in the Add Packet Filter Set screen (see the next section).

### *Adding a packet filter set*

To add a new IPX packet filter set, select **Add IPX Packet Filter Set** in the IPX Filters and Filter Sets screen and press Return. The Add Packet Filter Set screen appears.

```

Add Packet Filter Set

Filter Set Name:
Show Filters/Change Action on Match...
Append Filter...
Remove Filter...

ADD FILTER SET NOW                CANCEL

Return accepts * ESC cancels * Left/Right moves insertion point * Del deletes.
Configure an IPX Filter Set here. You must ADD FILTER SET NOW to save.

```

Follow these steps to configure the new packet filter set:

1. Select **Filter Set Name** and enter a descriptive name for the filter set.
2. To change the forwarding action of filters in the filter set, select **Show Filters/Change Action on Match** and press Return. The Show Filters/Change Actions on Match screen appears.

```

Show Filters/Change Actions on Match
Filter Name-----Forward
Filter 1                      No
Filter 2                      No
<<NO MATCH>>                 Yes

Set whether filters forward or drop matching packets here.

```

Select a filter and toggle the packet forwarding action to **Yes** (forward) or **No** (discard).

3. To add a filter to the filter set, select **Append Filter** to display a table of filters. Select a filter from the table and press Return to add it to the filter set. The default action of newly added filters is to *not* forward packets that match their criteria.  
To exit the table without adding the filter, press Escape.
4. To remove a filter from the filter set, select **Remove Filter** to display a table of appended filters. Select a filter from the table and press Return to remove it from the set. To exit the table without removing the filter, press Escape.
5. Select **ADD FILTER SET NOW** to save the current filter set. Select **CANCEL** to exit the Add Packet Filter Set screen without saving the new filter set.

### *Deleting a packet filter set*

To delete a packet filter set, select **Delete IPX Packet Filter Set** in the IPX Filters and Filter Sets screen to display a list of filter sets. Select a filter set from the list and press Return to delete it. Press the Escape key to exit the list without deleting the filter set.

**Note:** Deleting a filter set does not delete the filters in that set. However, the filters in the deleted set are no longer in effect (unless they are part of another set). The deleted set will no longer appear in the answer profile or any connection profiles to which it was added.

### *IPX SAP filters*

For each IPX SAP filter, you can configure a set of parameters to match on certain attributes of IPX SAP packet entries. The filters check IPX SAP packets for entries that match and then acts on those entries. The SAP packets themselves are always allowed to continue after their entries are checked.

The purpose of filtering SAP packets is not to make your network more secure, but to add efficiency to network bandwidth use. Filtering SAP packets may reduce the size of SAP packets and SAP bindery tables by removing unwanted entries.

### *Viewing and modifying SAP filters*

To display a table of IPX SAP filters, select **Display/Change IPX SAP Filters** in the IPX Filters and Filter Sets screen.

To modify any of the filters in the table, select the desired filter and press Return. The Change SAP Filter screen appears. The parameters in this screen are the same as the ones in the Add SAP Filter screen (see the next section).

### Adding a SAP filter

To add a new IPX SAP filter, select **Add IPX SAP Filter** in the IPX Filters and Filter Sets screen and press Return. The Add SAP Filter screen appears.

```

                                Add Sap Filter

Filter Name:
Server Name:
Socket:                               0000
Type:                                 0000
IPX Network:                          00000000
IPX Node Address:                      000000000000

                                ADD FILTER NOW                                CANCEL

Configure a new IPX SAP Filter. Finished?  ADD or CANCEL to exit.
```

By default, the filter's socket and type numbers and network and node addresses are null (all zeros). This sets the filter to match on any IPX SAP packet entry. Configure the filter using criteria that meet your needs.

Follow these steps to configure the new SAP filter:

1. Select **Filter Name** and enter a descriptive name for the filter.
2. To specify a server name for the filter to match on, select **Server Name** and enter the name of an IPX server. You can use the wildcard characters \* (asterisk) and ? (question mark). Use \* to match any string, including a null string (no characters), and ? to match any single character in the server's name. For example, the filter could match on the server name "NETOPIA" with "NETO\*", "NETO?IA", and "NETOPIA\*".
3. To specify a socket for the filter to match on, select **Socket** and enter an IPX socket number.
4. To specify a type number for the filter to match on, select **Type** and enter an IPX type number.
5. To specify an IPX network address for the filter to match on, select **IPX Network** and enter an IPX network address.
6. To specify an IPX node address for the filter to match on, select **IPX Node Address** and enter an IPX node address.
7. Select **ADD FILTER NOW** to save the current filter. Select **CANCEL** to exit the Add SAP Filter screen without saving the new filter.

### Deleting a SAP filter

To delete a SAP filter, select **Delete IPX SAP filter** in the IPX Filters and Filter Sets screen to display a table of filters. Select a filter from the table and press Return to delete it. Press Escape to exit the table without deleting the filter.



## IPX SAP filter sets

Before IPX SAP filters can be used, they must be grouped into sets. A SAP filter can be part of more than one filter set.

### Viewing and modifying SAP filter sets

To display a table of IPX SAP filter sets, select **Display/Change IPX SAP Filter Sets** in the IPX Filters and Filter Sets screen to display a list of filter sets.

To modify any of the filter sets in the list, select the desired filter set and go to the Change SAP Filter Set screen. The parameters in this screen are the same as the ones in the Add SAP Filter Set screen (see the next section).

### Adding a SAP filter set

To add a new IPX SAP filter set, select **Add IPX SAP Filter Set** in the IPX Filters and Filter Sets screen. The Add SAP Filter Set screen appears.

Add SAP Filter Set

Filter Set Name:

Show Filters/Change Action on Match...

Append Filter...

Remove Filter...

ADD FILTER SET NOW CANCEL

Configure an IPX Filter Set here. You must ADD FILTER SET NOW to save.

Follow these steps to configure the new SAP filter set:

1. Select **Filter Set Name** and enter a descriptive name for the filter set.
2. To change the forwarding action of filters in the filter set, select **Show Filters/Change Action on Match** and press Return. The Show Filters/Change Actions on Match screen appears.

Show Filters/Change Actions on Match	
Filter Name-----	Forward
Filter 1	No
Filter 2	No
<<NO MATCH>>	Yes

Set whether filters forward or drop matching packets here.

Select a filter and toggle the entry forwarding action to **Yes** (forward) or **No** (discard).

- To add a filter to the filter set, select **Append Filter** in the Add SAP Filter Set screen to display a table of filters. Select a filter from the table and press Return to add it to the filter set. The default action of newly added filters is to *not* forward (discard) packet entries that match their criteria.  
To exit the table without adding the filter, press Escape.
- To remove a filter from the filter set, select **Remove Filter** in the Add SAP Filter Set screen to display a table of appended filters. Select a filter from the table and press Return to remove it from the set. To exit the table without removing the filter, press Escape.
- To save the current filter set, select **ADD FILTER SET NOW** in the Add SAP Filter Set screen. Select **CANCEL** to exit the Add SAP Filter Set screen without saving the new filter set.

### *Deleting a SAP filter set*

To delete a SAP filter set, select **Delete IPX SAP Filter Set** in the IPX Filters and Filter Sets screen to display a list of filter sets. Select a filter set from the list and press Return to delete it. Press Escape to exit the list without deleting the filter set.

**Note:** Deleting a filter set does not delete the filters in that set. However, the filters in the deleted set are no longer in effect (unless they are part of another set). The deleted set will no longer appear in the answer profile or any connection profiles to which it was added.

---

## Firewall tutorial

### General firewall terms

**Filter rule:** A filter set is comprised of individual filter rules.

**Filter set:** A grouping of individual filter rules.

**Firewall:** A component or set of components that restrict access between a protected network and the Internet, or between two networks.

**Host:** A workstation on the network.

**Packet:** Unit of communication on the Internet.

**Packet filter:** Packet filters allow or deny packets based on source or destination IP addresses, TCP or UDP ports, or the TCP ACK bit.

**Port:** A number that defines a particular type of service.

### Basic IP packet components

All IP packets contain the same basic header information, as follows:

Source IP Address	163.176.132.18
Destination IP Address	163.176.4.27
Source Port	2541
Destination Port	80
Protocol	TCP
ACK Bit	Yes
DATA	User Data

This header information is what the packet filter uses to make filtering decisions. It is important to note that a packet filter does not look into the IP data stream (the User Data from above) to make filtering decisions.

### Basic protocol types

**TCP:** Transmission Control Protocol. TCP provides reliable packet delivery and has a retransmission mechanism (so packets are not lost). RFC 793 is the specification for TCP.

**UDP:** User Datagram Protocol. Unlike TCP, UDP does not guarantee reliable, sequenced packet delivery. If data does not reach its destination, UDP does not retransmit the data. RFC 768 is the specification for UDP.

There are many more ports defined in the Assigned Addresses RFC. The table that follows shows some of these port assignments.

*Example TCP/UDP Ports*

TCP Port	Service
20/21	FTP
23	Telnet
25	SMTP
80	WWW
144	News

UDP Port	Service
161	SNMP
69	TFTP
387	AURP

*Firewall design rules*

There are two basic rules to firewall design:

- "What is not explicitly allowed is denied."

and

- "What is not explicitly denied is allowed."

The first rule is far more secure, and is the best approach to firewall design. It is far easier (and more secure) to allow in or out only certain services and deny anything else. If the other rule is used, you would have to figure out everything that you want to disallow, now and in the future.

*Firewall Logic*

Firewall design is a test of logic, and filter rule ordering is critical. If a packet is forwarded through a series of filter rules and then the packet matches a rule, the appropriate action is taken. The packet will not forward through the remainder of the filter rules.

For example, if you had the following filter set...

- Allow WWW access;
- Allow FTP access;
- Allow SMTP access;
- Deny all other packets.

and a packet goes through these rules destined for FTP, the packet would forward through the first rule (WWW), go through the second rule (FTP), and match this rule; the packet is allowed through.

If you had this filter set for example....

```
Allow WWW access;
Allow FTP access;
Deny FTP access;
Deny all other packets.
```

and a packet goes through these rules destined for FTP, the packet would forward through the first filter rule (WWW), match the second rule (FTP), and the packet is allowed through. Even though the next rule is to deny all FTP traffic, the FTP packet will never make it to this rule.

### *Binary representation*

It is easiest when doing filtering to convert the IP address and mask in question to binary. This will allow you to perform the logical AND to determine whether a packet matches a filter rule.

### *Logical AND function*

When a packet is compared (in most cases) a logical AND function is performed. First the IP addresses and subnet masks are converted to binary and then combined with AND. The rules for the logical use of AND are as follows:

```
0 AND 0 = 0
0 AND 1 = 0
1 AND 0 = 0
1 AND 1 = 1
```

For example:

Filter rule:

Deny

IP: 163.176.1.15 BINARY: 10100011.10110000.00000001.00001111

Mask: 255.255.255.255 BINARY: 11111111.11111111.11111111.11111111

Incoming Packet:

IP 163.176.1.15 BINARY: 10100011.10110000.00000001.00001111

If you put the incoming packet and subnet mask together with AND, the result is:

10100011.10110000.00000001.00001111

which matches the IP address in the filter rule and the packet is denied.

*Implied rules*

With a given set of filter rules, there is an Implied rule that may or may not be shown to the user. The implied rule tells the filter set what to do with a packet that does not match any of the filter rules. An example of implied rules is as follows:

Implied	Meaning
Y+Y+Y=N	If all filter rules are YES, the implied rule is NO.
N+N+N=Y	If all filter rules are NO, the implied rule is YES.
Y+N+Y=N	If a mix of YES and NO filters, the implied rule is NO.

*Established connections*

The TCP header contains one bit called the ACK bit (or TCP Ack bit). This ACK bit appears only with TCP, not UDP. The ACK bit is part of the TCP mechanism that guarantees the delivery of data. The ACK bit is set whenever one side of a connection has received data from the other side. Only the first TCP packet will not have the ACK bit set; once the TCP connection is in place, the remainder of the TCP packets will have the ACK bit set.

The ACK bit is helpful for firewall design and reduces the number of potential filter rules. A filter rule could be created just allowing incoming TCP packets with the ACK bit set, since these packets had to be originated from the local network.

*Example IP filter set screen*

This is an example of the Netopia IP filter set screen:

```

Change Filter

Enabled:                               Yes
Forward:                               No

Source IP Address:                     0.0.0.0
Source IP Address Mask:                 0.0.0.0

Dest. IP Address:                       0.0.0.0
Dest. IP Address Mask:                 0.0.0.0

Protocol Type:                          TCP

Source Port Compare...                  No Compare
Source Port ID:                         0
Dest. Port Compare...                   Equal
Dest. Port ID:                           2000
Established TCP Conns. Only:            No

Return/Enter accepts * Tab toggles * ESC cancels.
Enter the IP specific information for this filter.

```

## Filter basics

In the source or destination IP address fields, the IP address that is entered must be the network address of the subnet. A host address can be entered, but the applied subnet mask must be 32 bits (255.255.255.255).

The Netopia R7200 has the ability to compare source and destination TCP or UDP ports. These options are as follows:

Item	What it means
No Compare	Does not compare TCP or UDP port
Not Equal To	Matches any port other than what is defined
Less Than	Anything less than the port defined
Less Than or Equal	Any port less than or equal to the port defined
Equal	Matches only the port defined
Greater Than or Equal	Matches the port or any port greater
Greater Than	Matches anything greater than the port defined

### Example network

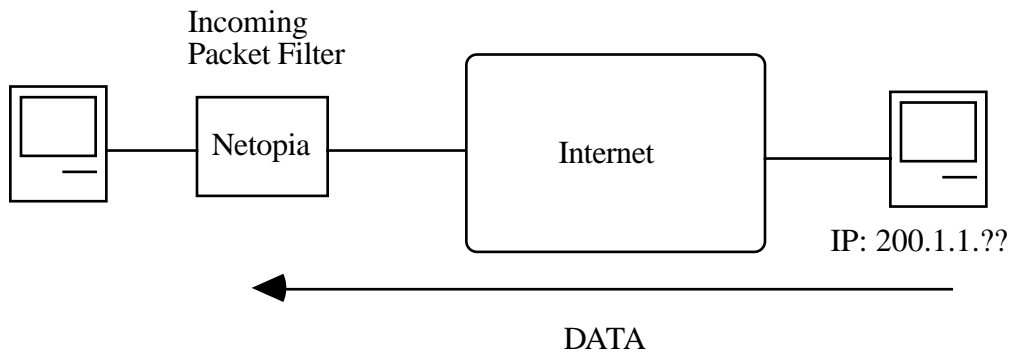

## Example filters

### Example 1

Filter Rule:	200.1.1.0	(Source IP Network Address)
	255.255.255.128	(Source IP Mask)
	Forward = No	(What happens on match)

Incoming packet has the source address of 200.1.1.28

IP Address	Binary Representation	
200.1.1.28	00011100	(Source address in incoming IP packet)
AND		
255.255.255.128	10000000	(Perform the logical AND)
	00000000	(Logical AND result)

This incoming IP packet has a source IP address that matches the network address in the Source IP Address field (00000000) in the Netopia R7200. This will *not* forward this packet.

### Example 2

Filter Rule:	200.1.1.0	(Source IP Network Address)
	255.255.255.128	(Source IP Mask)
	Forward = No	(What happens on match)

Incoming packet has the source address of 200.1.1.184.

IP Address	Binary Representation	
200.1.1.184	10111000	(Source address in incoming IP packet)
AND		
255.255.255.128	10000000	(Perform the logical AND)
	10000000	(Logical AND result)



This incoming IP packet (10000000) has a source IP address that does not match the network address in the Source IP Address field (00000000) in the Netopia R7200. This rule *will* forward this packet because the packet does not match.

### Example 3

Filter Rule:	200.1.1.96	(Source IP Network Address)
	255.255.255.240	(Source IP Mask)
	Forward = No	(What happens on match)

Incoming packet has the source address of 200.1.1.184.

IP Address	Binary Representation	
200.1.1.184	10111000	(Source address in incoming IP packet)
AND		
255.255.255.240	11110000	(Perform the logical AND)
	10110000	(Logical AND result)

Since the Source IP Network Address in the Netopia R7200 is 01100000, and the source IP address after the logical AND is 1011000, this rule does *not* match and this packet will be forwarded.

### Example 4

Filter Rule:	200.1.1.96	(Source IP Network Address)
	255.255.255.240	(Source IP Mask)
	Forward = No	(What happens on match)

Incoming packet has the source address of 200.1.1.104.

IP Address	Binary Representation	
200.1.1.104	01101000	(Source address in incoming IP packet)
AND		
255.255.255.240	11110000	(Perform the logical AND)
	01100000	(Logical AND result)

## 14-36 User's Reference Guide

Since the Source IP Network Address in the Netopia R7200 is 01100000, and the source IP address after the logical AND is 01100000, this rule *does* match and this packet will *not* be forwarded.

### Example 5

Filter Rule:	200.1.1.96	(Source IP Network Address)
	255.255.255.255	(Source IP Mask)
	Forward = No	(What happens on match)

Incoming packet has the source address of 200.1.1.96.

IP Address	Binary Representation	
200.1.1.96	01100000	(Source address in incoming IP packet)
AND		
255.255.255.255	11111111	(Perform the logical AND)
	01100000	(Logical AND result)

Since the Source IP Network Address in the Netopia R7200 is 01100000, and the source IP address after the logical AND is 01100000, this rule *does* match and this packet will *not* be forwarded. This rule masks off a *single* IP address.

## Chapter 15

# Utilities and Diagnostics

A number of utilities and tests are available for system diagnostic and control purposes.

This section covers the following topics:

- “Ping” on page 15-2
- “Trace Route” on page 15-4
- “Telnet client” on page 15-5
- “Disconnect Telnet console session” on page 15-6
- “Factory defaults” on page 15-6
- “Transferring configuration and firmware files with TFTP” on page 15-7
- “Transferring configuration and firmware files with XMODEM” on page 15-9
- “Restarting the system” on page 15-12

**Note:** These utilities and tests are accessible only through the console-based management screens. See Chapter 6, “Console-Based Management,” for information on accessing the console-based management screens.

You access the Utilities & Diagnostics screens from the Main Menu.

```
Utilities & Diagnostics

Ping...
Trace Route...
Telnet...

Disconnect Telnet Console Session...

Trivial File Transfer Protocol (TFTP)...
X-Modem File Transfer...

Revert to Factory Defaults...

Restart System...
```

## Ping

The Netopia R7200 includes a standard Ping test utility. A Ping test generates IP packets destined for a particular (Ping-capable) IP host. Each time the target host receives a Ping packet, it returns a packet to the original sender.

Ping allows you to see whether a particular IP destination is reachable from the Netopia R7200. You can also ascertain the quality and reliability of the connection to the desired destination by studying the Ping test's statistics.

In the Utilities & Diagnostic screen, select **Ping** and press Return. The ICMP Ping screen appears.

```

                                ICMP Ping

Name of Host to Ping:
Packets to Send:                5
Data Size:                      56
Delay (seconds):                1

                                START PING

Status:

Packets Out:                    0
Packets In:                     0
Packets Lost:                   0 (0%)
Round Trip Time
  (Min/Max/Avg):                0.000 / 0.000 / 0.000 secs

Enter the IP Address/Domain Name of a host to ping.
Send ICMP Echo Requests to a network host.

```

To configure and initiate a Ping test, follow these steps:

1. Select **Name of Host to Ping** and enter the destination domain name or IP address.
2. Select **Packets to Send** to change the default setting. This is the total number of packets to be sent during the Ping test. The default setting is adequate in most cases, but you can change it to any value from 1 to 4,294,967,295.
3. Select **Data Size** to change the default setting. This is the size, in bytes, of each Ping packet sent. The default setting is adequate in most cases, but you can change it to any value from 0 (only header data) to 1664.
4. Select **Delay (seconds)** to change the default setting. The delay, in seconds, determines the time between Ping packets sent. The default setting is adequate in most cases, but you can change it to any value from 0 to 4,294,967. A delay of 0 seconds forces packets to be sent immediately, one after another.
5. Select **START PING** and press Return to begin the Ping test. While the test is running, the **START PING** item becomes **STOP PING**. To manually stop the Ping test, select **STOP PING** and press Return or Escape.

While the Ping test is running and when it is over, a status field and a number of statistical items are active on the screen. These are described below.

**Status:** The current status of the Ping test. This item can display the status messages shown in the table below:

Message	Description
Resolving host name	Finding the IP address for the domain name-style address
Can't resolve host name	IP address can't be found for the domain name-style address
Pinging	Ping test is in progress
Complete	Ping test was completed
Cancelled by user	Ping test was cancelled manually
Destination unreachable from w.x.y.z	Ping test was able to reach the router with IP address w.x.y.z, which reported that the test could not reach the final destination
Couldn't allocate packet buffer	Couldn't proceed with Ping test; try again or reset system
Couldn't open ICMP port	Couldn't proceed with Ping test; try again or reset system

**Packets Out:** The number of packets sent by the Ping test.

**Packets In:** The number of return packets received from the target host. To be considered on time, return packets are expected back before the next packet in the sequence of Ping packets is sent. A count of the number of late packets appears in parentheses to the right of the **Packets In** count.

In the example that follows, a Netopia R7200 is sending Ping packets to another host, which responds with return Ping packets. Note that the second return Ping packet is considered to be late because it is not received by the Netopia R7200 before the third Ping packet is sent. The first and third return Ping packets are on time.

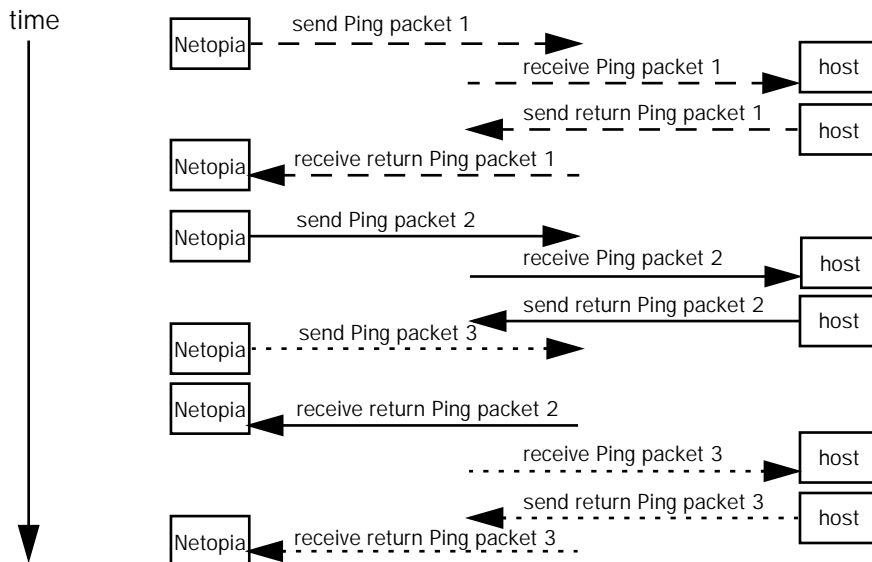

**Packets Lost:** The number of packets unaccounted for, shown in total and as a percentage of total packets sent. This statistic may be updated during the Ping test, and may not be accurate until after the test is over. However, if an escalating one-to-one correspondence is seen between **Packets Out** and **Packets Lost**, and **Packets In** is noticeably lagging behind **Packets Out**, the destination is probably unreachable. In this case, use **STOP PING**.

**Round Trip Time (Min/Max/Avg):** Statistics showing the minimum, maximum, and average number of seconds elapsing between the time each Ping packet was sent and the time its corresponding return Ping packet was received.

The time-to-live (TTL) value for each Ping packet sent by the Netopia R7200 is 255, the maximum allowed. The TTL value defines the number of IP routers that the packet can traverse. Ping packets that reach their TTL value are dropped, and a "destination unreachable" notification is returned to the sender (see the table on the previous page). This ensures that no infinite routing loops occur. The TTL value can be set and retrieved using the SNMP MIB-II ip group's ipDefaultTTL object.

---

## Trace Route

You can count the number of routers between your Netopia Router and a given destination with the Trace Route utility.

In the Statistics & Diagnostics screen, select **Trace Route** and press Return. The Trace Route screen appears.

Trace Route

Host Name or IP Address:

Maximum Hops: 30

Timeout (seconds): 5

Use Reverse DNS: Yes

START TRACE ROUTE

Enter the IP Address/Domain Name of a host.  
Trace route to a network host.

To trace a route, follow these steps:

1. Select **Host Name or IP Address** and enter the name or address of the destination you want to trace.
2. Select **Maximum Hops** to set the maximum number of routers to count between the Netopia Router and the destination router, up to the maximum of 64. The default is 30 hops.
3. Select **Timeout (seconds)** to set when the trace will timeout for each hop, up to 10 seconds. The default is 3 seconds.

4. Select **Use Reverse DNS** to learn the names of the routers between the Netopia Router and the destination router. The default is Yes.
5. Select **START TRACE ROUTE** and press Return. A scrolling screen will appear that lists the destination, number of hops, IP addresses of each hop, and DNS names, if selected.
6. Cancel the trace by pressing Escape. Return to the Trace Route screen by pressing Escape twice.

---

## Telnet client

The Telnet client mode replaces the normal menu mode. Telnet sessions can be cascaded, that is, you can initiate a Telnet client session when using a Telnet console session. To activate the Telnet client, select **Telnet** from the Utilities & Diagnostics menu.

The Telnet client screen appears.

```

                                Telnet
Host Name or IP Address:
Control Character to Suspend:      Q
                                START A TELNET SESSION

Enter the IP Address/Domain Name of a host.
```

- Enter the host name or the IP address in dotted decimal format of the machine you want to Telnet into and press Return.
- Either accept the default control character "Q" used to suspend the Telnet session, or type a different one.
- **START A TELNET SESSION** becomes highlighted.
- Press Return and the Telnet session will be initiated.
- To suspend the session, press Control-Q or whatever other control character you specified.

Two new options will appear in the Telnet screen (not shown):

**Resume Suspended Session** – select if you want to go back to your Telnet session

**Terminate Suspended Session** – select if you want to end the session

---

## Disconnect Telnet console session

If you want to close your Telnet console session, select **Disconnect Telnet Console Session** and press Return. A dialog box appears asking you to cancel or continue your selection.

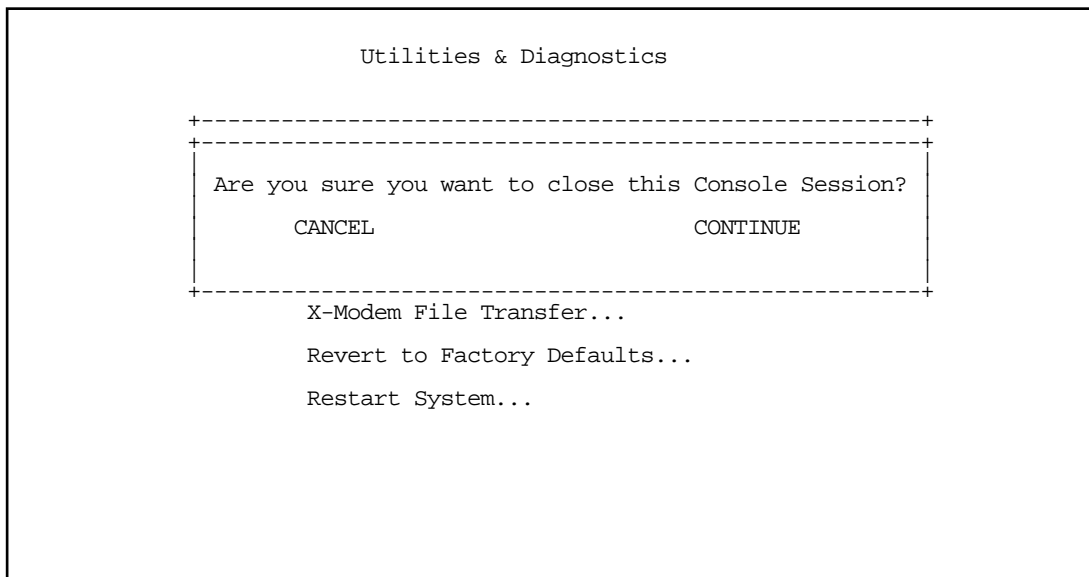

If you select **Continue**, you will immediately terminate your session.

---

## Factory defaults

You can reset the Netopia R7200 to its factory default settings. In the Utilities & Diagnostics screen, select **Revert to Factory Defaults** and press Return. Select **CONTINUE** in the dialog box and press Return. The Netopia R7200 will reboot and its settings will return to the factory defaults, deleting your configurations.

In an emergency, you can also use the Reset switch to return the router to its factory default settings. Call Netopia Technical Support for instructions on using the Reset switch.

**Note:** Reset to factory defaults with caution. You will need to reconfigure all of your settings in the router.

If you lose your password and are unable to access the console screens, you can manually reset the router in an emergency. See [Appendix A, "Troubleshooting."](#)



## Transferring configuration and firmware files with TFTP

Trivial File Transfer Protocol (TFTP) is a method of transferring data over an IP network. TFTP is a client-server application, with the router as the client. To use the Netopia R7200 as a TFTP client, a TFTP server must be available. Netopia, Inc., has a public access TFTP server on the Internet where you can obtain the latest firmware versions.

To use TFTP, select **Trivial File Transfer Protocol (TFTP)** in the Statistics & Diagnostics screen and press Return. The Trivial File Transfer Protocol (TFTP) screen appears.

```

Trivial File Transfer Protocol (TFTP)

TFTP Server Name:

Firmware File Name:
GET ROUTER FIRMWARE FROM SERVER...
GET WAN MODULE FIRMWARE FROM SERVER...

Config File Name:
GET CONFIG FROM SERVER...
SEND CONFIG TO SERVER...

TFTP Transfer State -- Idle

TFTP Current Transfer Bytes -- 0

```

The sections below describe how to update the Netopia R7200's firmware and how to download and upload configuration files.

### Updating firmware

Firmware updates may be available periodically from Netopia or from a site maintained by your organization's network administrator.

There are two types of firmware in the Netopia R7200 SDSL Router: router firmware and WAN module firmware. The router firmware governs how the router communicates with your network and the WAN module; the WAN module firmware governs how the WAN module communicates with the remote site. WAN module firmware is included on your Netopia CD for XMODEM transfer and later updates will be available on the Netopia website. Router firmware updates are also periodically posted on the Netopia website.

To update either the router's or the internal WAN module's firmware, follow these steps:

- Select **TFTP Server Name** and enter the server name or IP address of the TFTP server you will use. The server name or IP address is available from the site where the server is located.
- Select **Firmware File Name** and enter the name of the file you will download. The name of the file is available from the site where the server is located. You may need to enter a file path along with the file name (for example, bigroot/config/myfile).

- Select **GET ROUTER FIRMWARE FROM SERVER** or **GET WAN MODULE FIRMWARE FROM SERVER** and press Return. You will see the following dialog box:

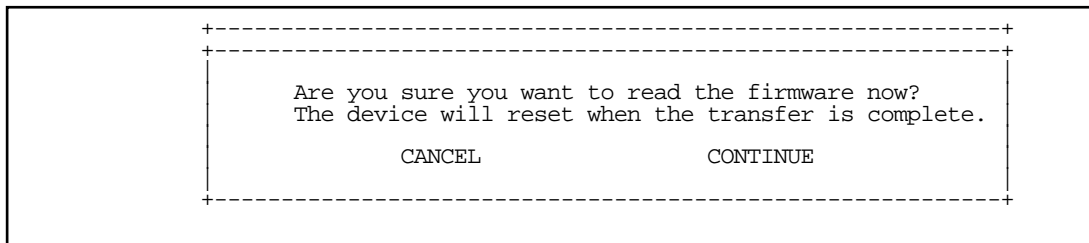

- Select **CANCEL** to exit without downloading the file, or select **CONTINUE** to download the file. The system will reset at the end of the file transfer to put the new firmware into effect. While the system resets, the LEDs will blink on and off.

### **Caution!**

- Be sure the firmware update you load onto your router is the correct version for your particular model. Some models do not support all firmware versions. Loading an incorrect firmware version can permanently damage the unit.
- Do not manually power down or reset the Netopia R7200 while it is automatically resetting or it could be damaged.
- If you choose to download the firmware, the **TFTP Transfer State** item will change from **Idle** to **Reading Firmware**. The **TFTP Current Transfer Bytes** item will reflect the number of bytes transferred.

## *Downloading configuration files*

The Netopia R7200 can be configured by downloading a configuration file using TFTP. Once downloaded, the file reconfigures all of the router's parameters as if someone had manually done so through the console port.

To download a configuration file, follow these steps:

- Select **TFTP Server Name** and enter the server name or IP address of the TFTP server you will use. The server name or IP address is available from the site where the server is located.
- Select **Config File Name** and enter the name of the file you will download. The name of the file is available from the site where the server is located. You may need to enter a file path along with the file name (for example, bigroot/config/myfile).



```

                                X-Modem File Transfer

Send Firmware to Netopia...
Send Config to Netopia...
Receive Config from Netopia...

Send Firmware to Netopia WAN module...
WAN module Firmware Status:          IDLE
```

## Updating firmware

Firmware updates may be available periodically from Netopia or from a site maintained by your organization's network administration. The procedure below applies whether you are using the console or the WAN interface module.

Follow these steps to update the Netopia R7200's firmware:

1. Make sure you have the firmware file on disk and know the path to its location.
2. Select **Send Firmware to Netopia** (or **Send Firmware to Netopia WAN module**) and press Return. The following dialog box appears:

```

+-----+
+-----+
| Are you sure you want to send a firmware file to your Netopia? |
| If so, when you hit Return/Enter on the CONTINUE button, you will |
| have 10 seconds to begin the transfer from your terminal program. |
|                               CANCEL                               |
|                               CONTINUE                             |
+-----+
+-----+
```

3. Select **CANCEL** to exit without downloading the file, or select **CONTINUE** to download the file.

If you choose CONTINUE, you will have ten seconds to use your terminal emulation software to initiate an XMODEM transfer of the firmware file. If you fail to initiate the transfer in that time, the dialog box will disappear and the terminal emulation software will inform you of the transfer's failure. You can then try again.

The system will reset at the end of a successful file transfer to put the new firmware into effect. While the system resets, the LEDs will blink on and off.

### Caution!

Do not manually power down or reset the Netopia R7200 while it is automatically resetting or it could be damaged.

## Downloading configuration files

The Netopia R7200 can be configured by downloading a configuration file. The downloaded file reconfigures all of the Router's parameters.

Configuration files are available from a site maintained by your organization's network administrator or from your local site (see "Uploading configuration files," below).

Follow these steps to download a configuration file:

1. Make sure you have the configuration file on disk and know the path to its location.
2. Select **Send Config to Netopia** and press Return. The following dialog box appears:

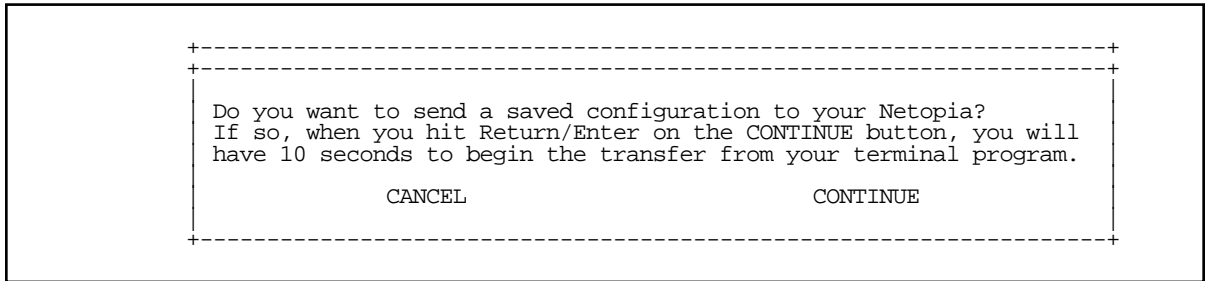

3. Select **CANCEL** to exit without downloading the file, or select **CONTINUE** to download the file.

If you choose CONTINUE, you will have ten seconds to use your terminal emulation software to initiate an XMODEM transfer of the configuration file. If you fail to initiate the transfer in that time, the dialog box will disappear and the terminal emulation software will inform you of the transfer's failure. You can then try again.

The system will reset at the end of a successful file transfer to put the new configuration into effect.

## Uploading configuration files

A file containing a snapshot of the Netopia R7200's current configuration can be uploaded from the router to disk. The file can then be downloaded by a different Netopia R7200 to configure its parameters (see "Downloading configuration files," above). This is useful for configuring a number of routers with identical parameters or for creating configuration backup files.

Uploading a file can also be useful for troubleshooting purposes. The uploaded configuration file can be tested on a different Netopia R7200 by Netopia or your network administrator.

The procedure below applies whether you are using the console or the WAN interface. To upload a configuration file:

1. Decide on a name for the file and a path for saving it.

2. Select **Receive Config from Netopia** and press Return. The following dialog box appears:

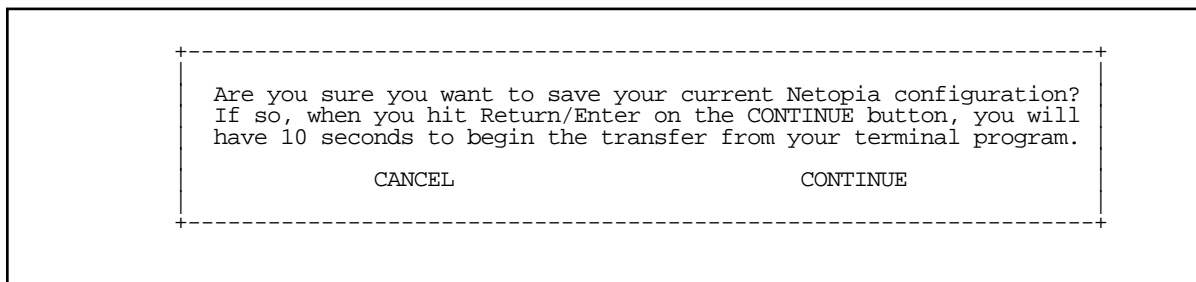

3. Select **CANCEL** to exit without uploading the file, or select **CONTINUE** to upload the file.

If you choose CONTINUE, you will have ten seconds to use your terminal emulation software to initiate an XMODEM transfer of the configuration file. If you fail to initiate the transfer in that time, the dialog box will disappear and the terminal emulation software will inform you of the transfer's failure. You can then try again.

---

## *Restarting the system*

You can restart the system by selecting the **Restart System** item in the Utilities & Diagnostics screen.

You must restart the system whenever you reconfigure the Netopia R7200 and want the new parameter values to take effect. Under certain circumstances, restarting the system may also clear up system or network malfunctions. Some configuration processes automatically restart the system to apply the changes you have made.

## ***Part III: Appendixes***





# Appendix A

## Troubleshooting

This appendix is intended to help you troubleshoot problems you may encounter while setting up and using the Netopia R7200. It also includes information on how to contact Netopia Technical Support.

Important information on these problems can be found in the event histories kept by the Netopia R7200. These event histories can be accessed in the Statistics & Logs screen.

This section covers the following topics:

- [“Configuration problems” on page A-1](#)
- [“How to reset the router to factory defaults” on page A-3](#)
- [“Power outages” on page A-3](#)
- [“Technical support” on page A-4](#)

---

### Configuration problems

If you encounter problems during your initial configuration process, review the following suggestions before calling for technical support. There are four zones to consider when troubleshooting initial configuration:

1. The computer’s connection to the router
2. The router’s connection to the telecommunication line(s)
3. The telecommunication line’s connection to your ISP
4. The ISP’s connection to the Internet

If the connection from the computer to the router was not successful, verify that the following conditions are in effect:

- The Netopia R7200 is turned on.
- An Ethernet cable connects your PC’s Ethernet card or built-in Ethernet port to the Netopia R7200.
- The SmartStart application is running and able to access the Netopia R7200.
- Telnet is available on your PC or Macintosh. (On a PC, it must be specified in your system path. You can usually find the application as “c:\windows\telnet.exe”.)
- Your PC or Macintosh is properly configured for TCP/IP.
- Your PC or Macintosh has an IP address.
- Your PC or Macintosh has a subnet mask that matches or is compatible with the Netopia R7200’s subnet mask.

**Note:** If you are attempting to modify the IP address or subnet mask from a previous, successful configuration attempt, you will need to clear the IP address or reset your Netopia R7200 to the factory default before reinitiating the configuration process. For further information on resetting your Netopia R7200 to factory default, see [“Factory defaults” on page 15-6](#).

### *Console connection problems*

#### *Can't see the configuration screens (nothing appears)*

- Make sure the cable connection from the Netopia R7200's console port to the computer being used as a console is securely connected.
- Make sure the terminal emulation software is accessing the correct port on the computer that's being used as a console.
- Try pressing Ctrl-L or Return or the up or down arrow key several times to refresh the terminal screen.
- Make sure that flow control on serial connections is turned off.

#### *Junk characters appear on the screen*

- Check that the terminal emulation software is configured correctly.
- Check the baud rate. The default values are 9600, N, 8, and 1.

#### *Characters are missing from some of the configuration screens*

- Try changing the Netopia R7200's default speed of 9600 bps and setting your terminal emulation software to match the new speed.

### *Network problems*

#### *Problems communicating with remote IP hosts*

- Verify the accuracy of the default gateway's IP address (entered in the IP Setup or Easy Setup screen).
- Use the Netopia R7200's Ping utility, in the Utilities & Diagnostics screen, and try to Ping local and remote hosts. See [“Ping” on page 15-2](#) for instructions on how to use the Ping utility. If you can successfully Ping hosts using their IP addresses but not their domain names (198.34.7.1 but not garcia.netopia.com, for example), verify that the DNS server's IP address is correct and that it is reachable from the Netopia R7200 (use Ping).
- If you are using filters, check that your filter sets are not blocking the type of connections you are trying to make.

#### *Local routing problems*

- Observe the Ethernet LEDs to see if data traffic flow appears to be normal.
- Check the WAN statistics and LAN statistics screens to see more specific information on data traffic flow and address serving. See [“Statistics & Logs” on page 13-4](#) for more information.

---

## How to reset the router to factory defaults

Lose your password? This section shows how to reset the router so that you can access the console screens once again. Keep in mind that all of your connection profiles and settings will need to be reconfigured.

If you don't have a password, the only way to get back into the Netopia R7200 is the following:

1. Turn the router upside down.
2. Referring to the diagram below, find the paper clip-size Reset Switch slot.

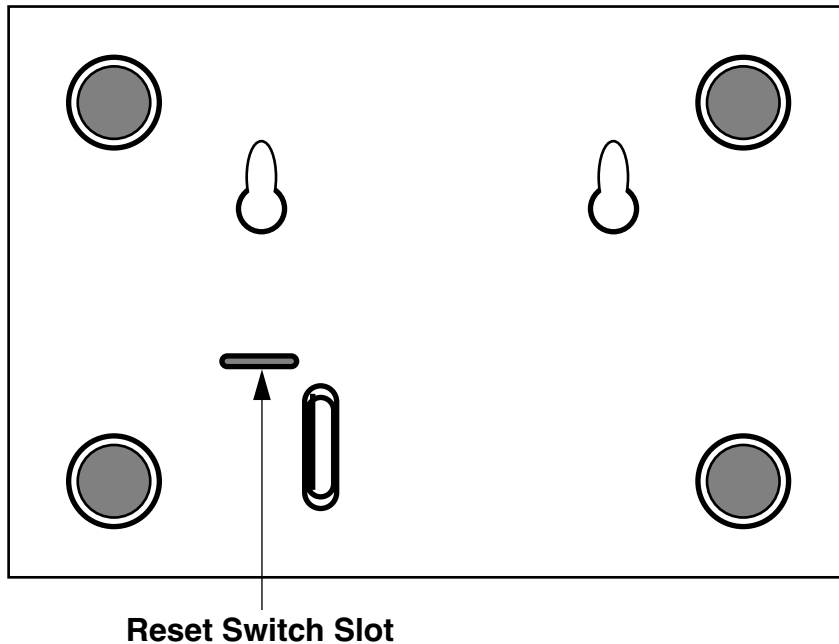

3. Carefully insert the larger end of a standard size paper clip until you contact the internal Reset Switch. (No need to unwind the paper clip.)
4. Press this switch.
5. This will reset the unit to factory defaults and you will now be able to reprogram the router.

---

## Power outages

If you suspect that power was restored after a power outage and the Netopia R7200 is connected to a remote site, you may need to switch the Netopia R7200 off and then back on again. After temporary power outages, a connection that still seems to be up may actually be disconnected. Rebooting the router should reestablish the connection.

## *Technical support*

Netopia, Inc. is committed to providing its customers with reliable products and documentation, backed by excellent technical support.

### *Before contacting Netopia*

Look in this guide for a solution to your problem. You may find a solution in this troubleshooting appendix or in other sections. Check the index for a reference to the topic of concern. If you cannot find a solution, complete the environment profile below before contacting Netopia Technical Support.

### *Environment profile*

- Locate the Netopia R7200's model number, product serial number, and firmware version. The serial number is on the bottom of the router, along with the model number. The firmware version appears in the Netopia R7200's Main Menu screen.

Model number:

Serial number:

Firmware version:

- What kind of local network(s) do you have, with how many devices?

Ethernet

LocalTalk

EtherTalk

TCP/IP

IPX

Other

## *How to reach us*

We can help you with your problem more effectively if you have completed the environment profile in the previous section. If you contact us by telephone, please be ready to supply Netopia Technical Support with the information you used to configure the Netopia R7200. Also, please be at the site of the problem and prepared to reproduce it and to try some troubleshooting steps.

When you are prepared, contact Netopia Technical Support by e-mail, telephone, fax, or post:

Internet: techsports@netopia.com (for technical support)  
info@netopia.com (for general information)

Phone: 1 800-782-6449

Fax: 1 510-814-5023

Netopia, Inc.

Customer Service

2470 Mariner Square Loop

Alameda, California 94501

USA

Netopia Bulletin Board Service: 1 510-865-1321

*Online product information*

Product information can be found in the following:

Netopia World Wide Web server via <http://www.netopia.com>  
Internet via anonymous FTP to <ftp.netopia.com/pub>

*FAX-Back*

This service provides technical notes that answer the most commonly asked questions and offers solutions for many common problems encountered with Netopia products.

FAX-Back: 1 510-814-5040



## Appendix B

# Understanding IP Addressing

This appendix is a brief general introduction to IP addressing. A basic understanding of IP will help you in configuring the Netopia R7200 and using some of its powerful features, such as static routes and packet filtering.

This section covers the following topics:

- “What is IP?” on page B-1
- “About IP addressing” on page B-1
- “Distributing IP addresses” on page B-5
- “Nested IP subnets” on page B-11
- “Broadcasts” on page B-13

---

### What is IP?

All networks use protocols to establish common standards for communication. One widely used network protocol is the Internet Protocol, also known as IP. Like many other protocols, IP uses packets, or formatted chunks of data, to communicate. In packets, a header is part of the envelope information that surrounds the actual data being transmitted. In e-mail, a header is usually the address and routing information found at the top of messages.

**Note:** This guide uses the term “IP” in a very general and inclusive way to identify all of the following:

- Networks that use the Internet Protocol, along with accompanying protocols such as TCP, UDP, and ICMP
- Packets that include an IP header within their structure
- Devices that send IP packets

---

### About IP addressing

Every networking protocol uses some form of addressing in order to ensure that packets are delivered correctly. In IP, individual network devices that are initial sources and final destinations of packets are usually called hosts instead of nodes, but the two terms are interchangeable. Each host on an IP network must have a unique IP address. An IP address, also called an Internet address, is a 32-bit number usually expressed as four decimal numbers separated by periods. Each decimal number in an IP address represents a 1-byte (8-bit) binary number. Thus, values for each of the four numbers range from 00000000 to 11111111 in binary notation, or from 0 to 255 in decimal notation. The expression 192.168.1.1 is a typical example of an IP address.

IP addresses indicate both the identity of the network and the identity of the individual host on the network. The number of bits used for the network number and the number of bits used for the host number can vary, as long as certain rules are followed. The local network manager assigns IP host numbers to individual machines.

## B-2 User's Reference Guide

IP addresses are maintained and assigned by the InterNIC, a quasi-governmental organization now increasingly under the auspices of private industry.

**Note:** It's very common for an organization to obtain an IP address from a third party, usually an Internet service provider (ISP). ISPs usually issue an IP address when they are contracted to provide Internet access services.

The InterNIC (the NIC stands for Network Information Center) divides IP addresses into several classes. Classes A, B, and C are assigned to organizations that request addresses. In Class A networks, the first byte of an IP address is reserved for the network portion of the address. Class B networks reserve the first two bytes of an IP address for the network address. Class C networks reserve the first three bytes of an IP address for the network address. In all cases, a network manager can decide to use subnetting to assign even more bits to the network portion of the IP address, but never less than the class requires. The following section gives more information on subnetting.

Class A networks have a small number of possible network numbers, but a large number of possible host numbers. Conversely, Class C networks have a small number of possible host numbers, but a large number of possible network numbers. Thus, the InterNIC assigns Class A addresses to large organizations that have very large numbers of IP hosts, while smaller organizations, with fewer hosts, get Class B or Class C addresses. You can tell the various classes apart by the value of the first (or high-order) byte. Class A networks use values from 1 to 127, Class B networks use values from 128 to 191, and Class C networks use values from 192 to 223. The following table summarizes some of the differences between Class A, B, and C networks.

Class	First byte	Number of networks possible per class	Number of hosts possible per network	Format of address (without subnetting)	Example
A	1–127	127	16,777,214	net.host.host.host	97.3.14.250
B	128–191	16,384	65,534	net.net.host.host	140.100.10.11
C	192–223	2,097,152	254	net.net.net.host	197.204.13.7

## Subnets and subnet masks

Often an entire organization is assigned only one IP network number. If the organization has several IP networks connected together with IP routers, the network manager can use subnetting to distinguish between these networks, even though they all use the same network number. Each physical network becomes a subnet with a unique subnet number.

Subnet numbers appear within IP addresses, along with network numbers and host numbers. Since an IP address is always 32 bits long, using subnet numbers means either the network number or the host numbers must use fewer bits in order to leave room for the subnet numbers. Since the InterNIC assigns the network number proper, it should not change, so the subnet numbers must be created out of bits that would otherwise be part of the host numbers.



### Subnet masks

To create subnets, the network manager must define a subnet mask, a 32-bit number that indicates which bits in an IP address are used for network and subnetwork addresses and which are used for host addresses. One subnet mask should apply to all IP networks that are physically connected together and share a single assigned network number. Subnet masks are often written in decimal notation like IP addresses, but they are most easily understood in binary notation. When a subnet mask is written in binary notation, each numeral 1 indicates that the corresponding bit in the IP address is part of the network or subnet address. Each 0 indicates that the corresponding bit is part of the host address. The following table shows the proper subnet masks to use for each class of network when no subnets are required.

Class	Subnet mask for a network with no subnets
A	Binary: 11111111.00000000.00000000.00000000 Decimal: 255.0.0.0
B	Binary: 11111111.11111111.00000000.00000000 Decimal: 255.255.0.0
C	Binary: 11111111.11111111.11111111.00000000 Decimal: 255.255.255.0

To know whether subnets are being used or not, you must know what subnet mask is being used—you cannot determine this information simply from an IP address. Subnet mask information is configured as part of the process of setting up IP routers and gateways such as the Netopia R7200.

**Note:** If you receive a routed account from an ISP, there must be a mask associated with your network IP address. By using the IP address with the mask you can discover exactly how many IP host addresses you actually have.

To configure subnets properly, you must also be able to convert between binary notation and decimal notation.

### *Example: Using subnets on a Class C IP internet*

When setting up IP routing with a Class A address, or even with multiple Class C addresses, subnetting is fairly straightforward. Subnetting a single Class C address between two networks, however, is more complex. This section describes the general procedures for subnetting a single Class C network between two Netopia routers so that each can have Internet access.

Network configuration

Below is a diagram of a simple network configuration. The ISP is providing a Class C address to the customer site, and both networks A and B want to gain Internet access through this address. Netopia R7200 B connects to Netopia R7200 A and is provided Internet access through Routers A and B.

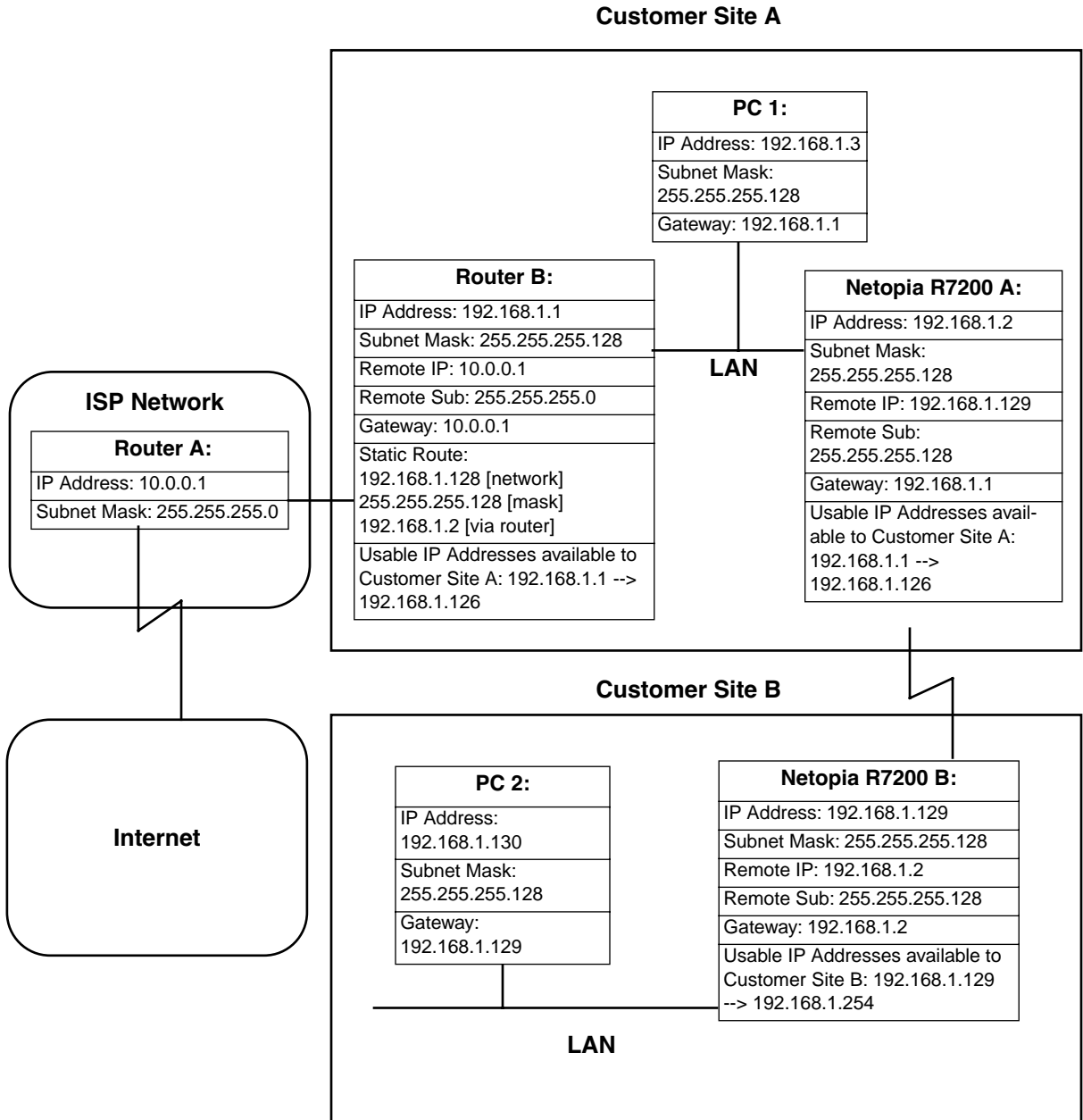

## Background

The IP addresses and routing configurations for the devices shown in the diagram are outlined below. In addition, each individual field and its meaning are described.

The IP Address and Subnet Mask fields define the IP address and subnet mask of the device's Ethernet connection to the network while the Remote IP and Remote Sub fields describe the IP address and subnet mask of the remote router. This information is entered in the connection profile of the Netopia R7200.

The Gateway field describes the router or workstation's default gateway, or where they will send their packets if the appropriate route is not known. The Static Route field, which is only shown on Router B, tells Router B what path to take to get to the network defined by Netopia R7200 B. Finally, the Usable IP Address field shows the range of IP addresses available to the hosts of that network.

Note that the IP addresses given in this section are for example purposes only. Do not use these addresses when configuring your network.

With this configuration, both Customer Site A and B can gain Internet access through Routers A and B, with no reconfiguration of the ISP's equipment. The most important item in this configuration is the static route defined on Router B. This tells Router B what path to take to get to the network defined by Netopia R7200 B. Without this information, Customer Site B will be able to access Customer Site A, but not the Internet.

If it is not possible to define a static route on Router B, RIP could be enabled to serve the same purpose. To use RIP instead of a static route, enable Transmit RIP on Netopia R7200 A and Transmit and Receive RIP on Router B. This will allow the route from Customer Site B to propagate on Router B and Customer Site A.

## Example: Working with a Class C subnet

Suppose that your organization has a site with only 10 hosts and no plans to add any new hosts. You don't need a full Class C address for this site. Many ISPs offer Internet access with only a portion of a full Internet address.

For example, you might obtain the Class C address 199.14.17.48, with the mask 255.255.255.240. From the previous example, you can see that this gives you 14 host addresses to distribute to the hosts at your site. In effect, your existing network of 10 hosts is a subnet of the ISP's network. Since the Class C address has already been reduced to subnets, you cannot further subnet your network without the risk of creating network routing problems (since you must use the mask issued by the ISP). This, however, is not a problematic limitation for your small network.

The advantages of this situation are the greater ease and lower cost of obtaining a subnet rather than a full Class C address from an ISP.

---

## Distributing IP addresses

To set up a connection to the Internet, you may have obtained a block of IP host addresses from an ISP. When configuring the Netopia R7200, you gave one of those addresses to its Ethernet port, leaving a number of addresses to distribute to computers on your network.

## B-6 User's Reference Guide

There are two schemes for distributing the remaining IP addresses:

- Manually give each computer an address
- Let the Netopia R7200 automatically distribute the addresses

These two methods are not mutually exclusive; you can manually issue some of the addresses while the rest are distributed by the Netopia R7200. Using the router in this way allows it to function as an address server.

One reason to use the Netopia R7200 as an address server is that it takes less time than manually distributing the addresses. This is particularly true if you have many addresses to distribute. You need to enter information only once, rather than having to enter it on each host separately. This also reduces the potential for misconfiguring hosts.

Another reason to use the Netopia R7200 as an address server is that it will distribute addresses only to hosts that need to use them.

All Netopia R7200s come with an integrated Dynamic Host Control Protocol (DHCP) server. Some routers also come with a Macintosh Internet Protocol (MacIP) server. These servers provide a means of distributing IP addresses to either a Mac or PC workstation as needed.

When setting up the DHCP or MacIP servers in the Netopia R7200, it is necessary to understand how workstations lease, renew, and release their IP addresses. This information is helpful in determining dynamic address allocation for a network.

The term "lease" describes the action of a workstation requesting and using an IP address. The address is dynamic and can be returned to the address pool at a later time.

The term "renew" refers to what the workstations do to keep their leased IP address. At certain intervals, the workstation talks to the DHCP or MacIP server and renews the lease on that IP address. This renewal allows the workstation to keep and use the assigned IP address until the next renewal period.

The term "release" refers to a situation where the workstation is no longer using its assigned IP address or has been shut down. IP addresses can be manually released as well. The IP address goes back into the DHCP or MacIP address pool to be reassigned to another workstation as needed.

### *Technical note on subnet masking*

**Note:** The IP address supplied by the Netopia R7200 will be a unique number. You may want to replace this number with a number that your ISP supplies if you are configuring the router for a static IP address. The automatic IP mask supplied by SmartStart is a Class C address. However, the Netopia R7200 and all devices on the same local network must have the same subnet mask. If you require a different class address, you can edit the IP Mask field to enter the correct address. Refer to the table below.

Number of Devices (other than Netopia R7200) on Local Network	Largest Possible Ethernet Subnet Mask
1	255.255.255.252
2-5	255.255.255.248
6-13	255.255.255.240
14-29	255.255.255.224

Number of Devices (other than Netopia R7200) on Local Network	Largest Possible Ethernet Subnet Mask
30-61	255.255.255.192
62-125	255.255.255.128
125-259	255.255.255.0

## Configuration

This section describes the specific IP address lease, renew, and release mechanisms for both the Mac and PC, with either DHCP or MacIP address serving.

### DHCP address serving

#### Windows 95 workstation:

- The Win95 workstation requests and renews its lease every half hour.
- The Win95 workstation does NOT relinquish its DHCP address lease when the machine is shut down.
- The lease can be manually expired using the WINIPCFG program, a command line program executable from the DOS prompt or from the START:RUN menu on a Windows-based computer.

#### Windows 3.1 workstation (MSTCP Version 3.11a):

- The Win3.1 workstation requests and renews its lease every half hour.
- The Win3.1 workstation does NOT relinquish its DHCP address lease when the user exits Windows and goes to DOS.
- The lease can be manually expired by typing IPCONFIG/RELEASE from a DOS window within Windows or from the DOS prompt.

#### Macintosh workstation (Open Transport Version 1.1 or later):

- The Mac workstation requests and renews its lease every half hour.
- The Mac workstation relinquishes its address upon shutdown in all but one case. If the TCP/IP control panel is set to initialize at startup, and no IP services are used or the TCP/IP control panel is not opened, the DHCP address will NOT be relinquished upon shutdown. However, if the TCP/IP control panel is opened or if an IP application is used, the Mac WILL relinquish the lease upon shutdown.
- If the TCP/IP control panel is set to acquire an address only when needed (therefore a TCP/IP application must have been launched to obtain a lease) the Mac WILL relinquish its lease upon shutdown every time.

### Netopia R7200 DHCP server characteristics

- The Netopia R7200 ignores any lease-time associated with a DHCP request and automatically issues the DHCP address lease for one hour.
- The number of devices a Netopia R7200 can serve DHCP to is 512. This is imposed by global limits on the size of the address serving database, which is shared by all address serving functions active in the router.

## ***B-8 User's Reference Guide***

- The Netopia R7200 releases the DHCP address back to the available DHCP address pool exactly one hour after the last-heard lease request. Some other DHCP implementations may hold on to the lease for an additional time after the lease expired to act as a buffer for variances in clocks between the client and server.

### *MacIP serving*

#### **Macintosh workstation** (MacTCP or Open Transport):

Once the Mac workstation requests and receives a valid address, the Netopia R7200 actively checks for the workstation's existence once every minute.

- For a dynamic address, the Netopia R7200 releases the address back to the address pool after it has lost contact with the Mac workstation for over 2 minutes.
- For a static address, the Netopia R7200 releases the address back to the address pool after it has lost contact with the Mac workstation for over 20 minutes.

#### **Netopia R7200 MacIP server characteristics**

The Mac workstation uses ATP to both request and receive an address from the Netopia R7200's MacIP server. Once acquired, NBP confirm packets will be sent out every minute from the Netopia R7200 to the Mac workstation.

### *Manually distributing IP addresses*

If you choose to manually distribute IP addresses, you must enter each computer's address into its TCP/IP stack software. Once you manually issue an address to a computer, it possesses that address until you manually remove it. That's why manually distributed addresses are called static addresses.

Static addresses are useful in cases when you want to make sure that a host on your network cannot have its address taken away by the address server. Appropriate candidates for a static address include a network administrator's computer, a computer dedicated to communicating with the Internet, and routers.

### *Using address serving*

The Netopia R7200 provides three ways to serve IP addresses to computers on a network. The first, Dynamic Host Configuration Protocol (DHCP), is supported by PCs with Microsoft Windows and a TCP/IP stack. Macintosh computers using Open Transport and computers using the UNIX operating system may also be able to use DHCP. The second way, MacIP, is for Macintosh computers. The third way, called Serve Dynamic WAN Clients (IPCP), is used to fulfill WAN client requirements.

The Netopia R7200 can use both DHCP and MacIP. Whether you use one or both depends on your particular networking environment. If that environment includes both PCs and Macintosh computers that do not use Open Transport, you need to use both DHCP and MacIP to distribute IP addresses to all of your computers.

#### *Serve dynamic WAN clients*

The third method, used to fulfill WAN client requirements, is called Serve Dynamic WAN Clients. The correct term or protocol is a subset of the PPP suite call IPCP. Originally, this would apply only to switched WAN interface routers, and not to leased line routers. However, a new feature can give you Asynchronous PPP dial-in support on the Auxiliary port on any router including leased line Netopia routers.

In any situation where a device is dialing into a Netopia router, the router may need to be configured to serve IP via the WAN interface. This is only a requirement if the calling device has not been configured locally to know what its address(es) are. So when a client, dialing into a Netopia router's WAN interface, is expecting addresses to be served by the answering router, you must set the answering Netopia router to serve IP via its WAN interface.

You can do this in either of two ways:

- use the Serve Dynamic WAN Clients option in the Address Serving Setup screen.

Enabling Serve Dynamic WAN Clients only allows you to specify a pool of addresses from which the dial-in client may get an IP address. It does not allow static addressing.

If you want to serve addresses dynamically, use Serve Dynamic WAN Clients.

- define the address that you want to serve in the Connection Profile's IP Setup screen.

This method requires a static value to be used. Thus any user dialing in can obtain the same IP address for every connection to the profile.

If you want to serve addresses statically, define the address in the Connection Profile.

**Notes:**

- The addresses that are to be served cannot be used elsewhere. For example you wouldn't want to define a static address in a Connection Profile to be served via the WAN that is already defined in the DHCP pool of addresses.
- In order to work correctly, you must define a host or node address in the IP Profile Parameters of the Connection Profile.

This is accomplished by specifying the IP address that is to be statically served via the WAN, and then by entering a mask value of 255.255.255.255.

### *Tips and rules for distributing IP addresses*

- Before you allocate IP addresses using DHCP and MacIP, consider whether you need to set aside any static addresses.
- Note any planned and currently used static addresses before you use DHCP and MacIP.
- Avoid fragmenting your block of IP addresses. For example, try to use a continuous range for the static addresses you choose.

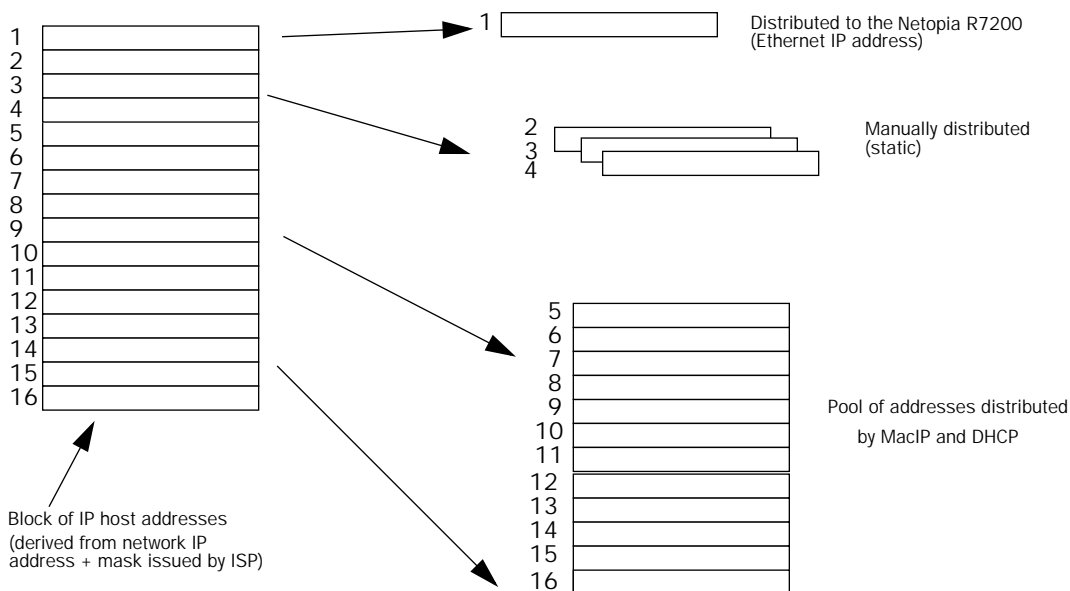

The figure above shows an example of a block of IP addresses being distributed correctly.

The example follows these rules:

- An IP address must not be used as a static address if it is also in a range of addresses being distributed by DHCP or MacIP.
- A single IP address range is used by all the address-served clients. These include DHCP, BootP, MacIP, and WAN clients, even though BootP and static MacIP clients might not be considered served.
- The address range specified for address-served clients cannot wrap around from the end of the total available range back to the beginning. See below for a further explanation and an example.
- The network address issued by an ISP cannot be used as a host address.

### A DHCP example

Suppose, for example, that your ISP gave your network the IP address 199.1.1.32 and a 4-bit subnet mask. Address 199.1.1.32 is reserved as the network address. Address 199.1.1.47 is reserved as the broadcast address. This leaves 14 addresses to allocate, from 199.1.1.33 through 199.1.1.46. If you want to allocate a sub-block of 10 addresses using DHCP, enter "10" in the DHCP Setup screen's **Number of Addresses to Allocate** item. Then, in the same screen's **First Address** item, enter the first address in the sub-block to allocate so that all 10 addresses are within your original block. You could enter 199.1.1.33, or 199.1.1.37, or any address between them. Note that if you entered 199.1.1.42 as the first address, network routing errors would probably result because you would be using a range with addresses that do not belong to your network (199.1.1.49, 199.1.1.50, and 199.1.1.51).



## Nested IP subnets

Under certain circumstances, you may want to create remote subnets from the limited number of IP addresses issued by your ISP or other authority. You can do this using connection profiles. These subnets can be nested within the range of IP addresses available to your network.

For example, suppose that you obtain the Class C network address a.b.c.0 to be distributed among three networks. This network address can be used on your main network, while portions of it can be subnetted to the two remaining networks.

**Note:** The IP address a.b.c.0 has letters in place of the first three numbers to generalize it for this example.

The figure shows a possible network configuration following this scheme. The main network is set up with the Class C address a.b.c.0, and contains Router A (which could be a Netopia R7200), a Netopia R7200, and a number of other hosts. Router A maintains a link to the Internet and can be used as the default gateway.

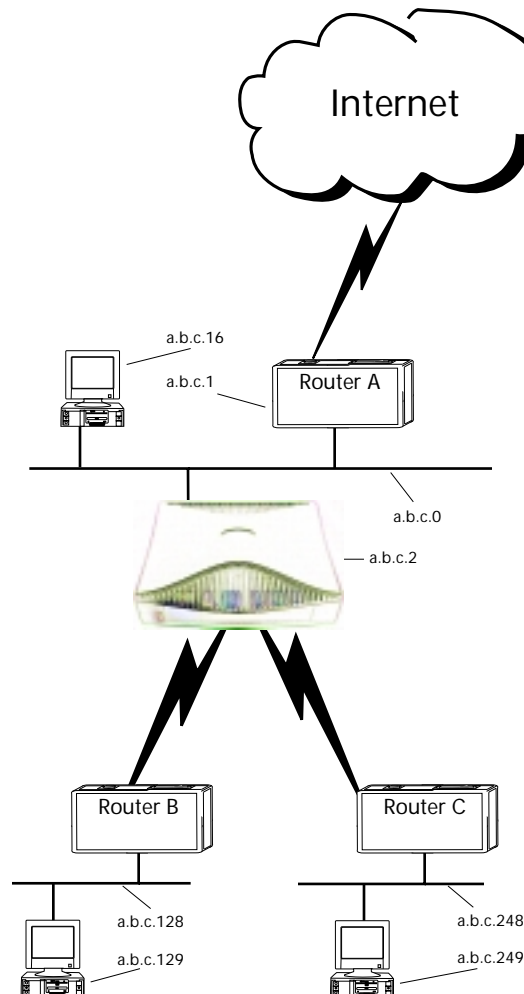

## B-12 User's Reference Guide

Routers B and C (which could also be Netopia R7200s) serve the two remote networks that are subnets of a.b.c.0. The subnetting is accomplished by configuring the Netopia R7200 with connection profiles for Routers B and C (see the following table).

Connection profile	Remote IP address	Remote IP mask	Bits available for host address
For Router B	a.b.c.128	255.255.255.192	7
For Router C	a.b.c.248	255.255.255.248	3

The Netopia R7200's connection profiles for Routers B and C create entries in its IP routing table. One entry points to the subnet a.b.c.128, while a second entry points to the subnet a.b.c.248. The IP routing table might look similar to the following:

IP Routing Table						
Network Address	Subnet Mask	via Router	Port	Age	Type	
0.0.0.0	0.0.0.0	a.b.c.1	WAN	3719	Management	
127.0.0.1	255.255.255.255	127.0.0.1	lp1	6423	Local	
a.b.c.128	255.255.255.192	a.b.c.128	WAN	5157	Local	
a.b.c.248	255.255.255.248	a.b.c.248	WAN	6205	Local	
-----SCROLL DOWN-----						
UPDATE						

Let's see how a packet from the Internet gets routed to the host with IP address a.b.c.249, which is served by Router C. The packet first arrives at Router A, which delivers it to its local network (a.b.c.0). The packet is then received by the Netopia R7200, which examines its destination IP address.

The Netopia R7200 compares the packet's destination IP address with the routes in its IP routing table. It begins with the route at the bottom of the list and works up until there's a match or the route to the default gateway is reached.

When a.b.c.249 is masked by the first route's subnet mask, it yields a.b.c.248, which matches the network address in the route. The Netopia R7200 uses the connection profile associated with the route to connect to Router C, and then forwards the packet. Router C delivers the packet to the host on its local network.

The following diagram illustrates the IP address space taken up by the two remote IP subnets. You can see from the diagram why the term nested is appropriate for describing these subnets.

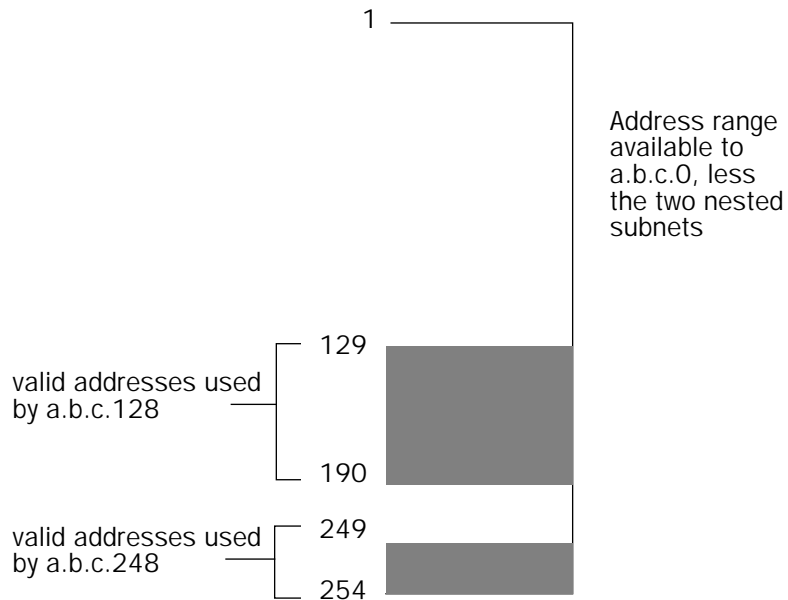

---

## Broadcasts

As mentioned earlier, binary IP host or subnet addresses composed entirely of ones or zeros are reserved for broadcasting. A broadcast packet is a packet that is to be delivered to every host on the network if both the host address and the subnet address are all ones or all zeros, or to every host on the subnetwork if the host address is all ones or all zeros but the subnet address is a combination of zeros and ones. Instead of making many copies of the packet, individually addressed to different hosts, all the host machines know to pay attention to broadcast packets, as well as to packets addressed to their specific individual host addresses. Depending on the age and type of IP equipment you use, broadcasts will be addressed using either all zeros or all ones, but not both. If your network requires zeros broadcasting, you must configure this through SNMP.

## Packet header types

As previously mentioned, IP works with other protocols to allow communication over IP networks. When IP is used on an Ethernet network, IP works with the Ethernet or 802.3 framing standards, among other protocols. These two protocols specify two different ways to organize the very first signals in the sequence of electrical signals that make up an IP packet travelling over Ethernet. By default, the Netopia R7200 uses Ethernet packet headers for IP traffic. If your network requires 802.3 IP framing, you must configure this through SNMP.



## Appendix C

### Understanding Netopia NAT Behavior

The Netopia R7200 implements a powerful feature called Network Address Translation (NAT) as specified in RFC 1631. NAT is used for IP address conservation and for security purposes since there will only be a single IP "presence" on the WAN. This appendix describes the NAT functionality within the Netopia R7200 and provides examples for setup and use.

---

#### Network configuration

Below is a diagram of the network referenced in this appendix.

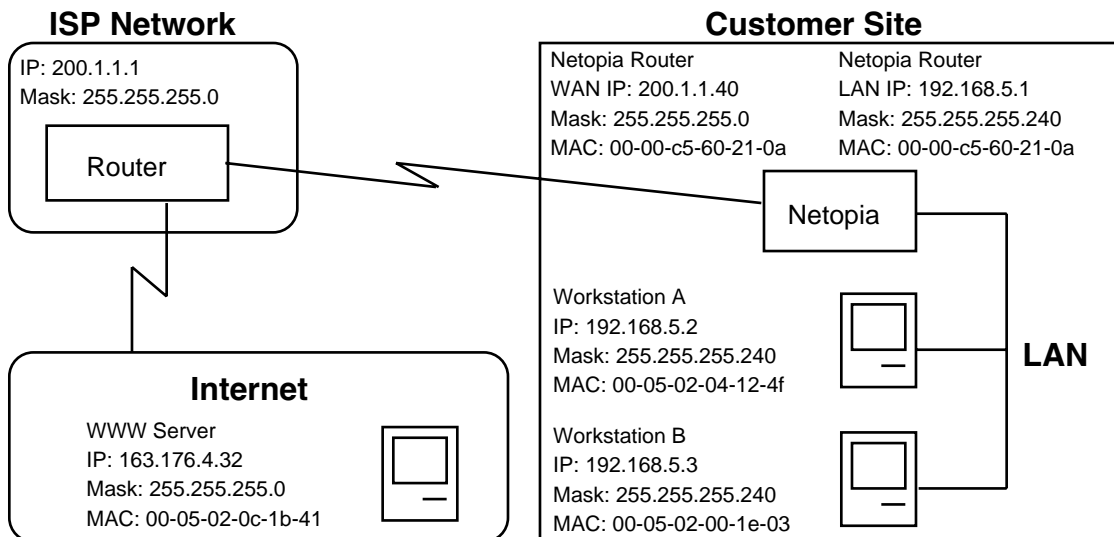

---

#### Background

NAT is a mechanism employed within the Netopia R7200 to acquire a statically or dynamically assigned IP address on its WAN interface and proxy against locally assigned IP addresses on its LAN interface. The Netopia R7200 uses a one-to-many IP address mapping scheme; that is against a single IP address the Netopia R7200 acquires on its WAN interface, the Netopia R7200 can proxy 14, 30, or an unlimited number of IP hosts on the LAN interface.

In order to fully understand how NAT works, you must understand how a PPP connection is established and IP addresses are negotiated.

## C-2 User's Reference Guide

When the Netopia R7200 establishes a connection over its WAN interface with another router it uses the Point-to-Point Protocol (PPP). Within PPP there is a Network Control Protocol (NCP) called Internet Protocol Control Protocol (IPCP), which handles the negotiation of IP addresses between the two routers, in this case the Netopia R7200 at the customer site above and the router at the Internet service provider (ISP).

If the Netopia R7200 calls the router at the ISP with NAT disabled, the Netopia negotiates its LAN interface address (as specified in IP Setup within the Netopia R7200's console) with the router at the ISP through IPCP and then sets up routing. From the diagram on the previous page you can see that the address for the Netopia R7200 is 192.168.5.1 and the address of the router at the ISP is 200.1.1.1. Assuming that the addresses negotiated by the routers are valid and unique for the Internet, the Netopia R7200 and the hosts on its LAN would be able to access the Internet.

If the Netopia R7200 calls the router at the ISP with NAT enabled, instead of negotiating the LAN interface address, the Netopia R7200 suggests the address 0.0.0.0 through IPCP. When the router at the ISP sees this all-zeros IPCP request, the router can either pull a free dynamic IP address from its pool and assign it to the Netopia R7200's WAN interface or, if configured to do so, it can match the Netopia R7200's incoming connection profile and assign a preconfigured static IP address to the Netopia R7200's WAN interface.

From the diagram, you can see that the IP address assigned to the Netopia R7200's WAN interface is 200.1.1.40, while the IP address assigned to the LAN interface remains the same. The LAN interface address 192.168.5.1 is thus hidden from the ISP and the Internet, and the Netopia R7200 only has a single valid IP presence on the Internet. The LAN interface IP address for the Netopia R7200 can be any IP address; however, it is recommended that you use the IANA-specified 192.168.X.X Class C address range, which is used for networks not attached to the Internet. This address range is described in RFC 1597.

The dynamic IP address acquisition on the WAN interface of the Netopia R7200 is one of several features of NAT. Another is the mapping of locally assigned IP addresses to the single globally unique IP address acquired by the Netopia R7200 on its WAN interface. NAT employs several things to accomplish this seamlessly. You must look at the formatting of an IP packet before IP address remapping can be explained.

Every IP packet that is transmitted across the Netopia R7200's LAN interface or across the WAN interface to the Internet contains several bits of information that indicate to any device where the packet is going and where it came from. In particular, you have the source and destination port and source and destination IP addresses.

A port is used within IP to define a particular type of service and could be either a Transmission Control Protocol (TCP) port or User Datagram Protocol (UDP) port. Both TCP and UDP are protocols that use IP as the underlying transport mechanism. The major difference between TCP and UDP is that TCP is a reliable delivery service, whereas UDP is a "best-effort" delivery service. A list of well-known TCP or UDP ports and services can be found in RFC 1700.

If Workstation A wants to communicate with a World Wide Web (WWW) server on the Internet and the Netopia R7200 does not have NAT enabled, Workstation A forms an IP packet with the source IP address of 192.168.5.2 and destination IP address of 163.176.4.32. The source port could be 400 while the destination port would be 80 (WWW server). The Netopia R7200 then looks at this IP packet, determines the best routing method and sends that packet on its way across the WAN interface to the WWW server on the Internet.

With NAT enabled, the Netopia R7200 does something different. For example, suppose that Workstation A again wants to communicate with the WWW server on the Internet. Workstation A forms an IP packet with the source IP address of 192.168.5.2 and destination IP address of 163.176.4.32, and source port could be 400 while the destination port would be 80 (WWW server).

When the Netopia R7200 receives this IP packet, it cannot simply forward it to the WAN interface and the Internet since the IP addresses on the LAN interface are not valid or globally unique for the Internet. Instead, the Netopia R7200 has to change the IP packet to reflect the IP address that was acquired on the WAN interface from the ISP.

The Netopia R7200 will first substitute the source IP address with the IP address that was acquired on the WAN interface, which in this case is 200.1.1.40. Next the Netopia R7200 will substitute the source TCP or UDP port with a TCP or UDP port from within a specified range maintained within the Netopia R7200. And finally the modified IP packet's checksum is recalculated (as specified in RFC 1631) and the packet is transmitted across the WAN interface to its destination, the WWW server on the Internet.

If the send and response IP packets were drawn out, this process would look like the following:

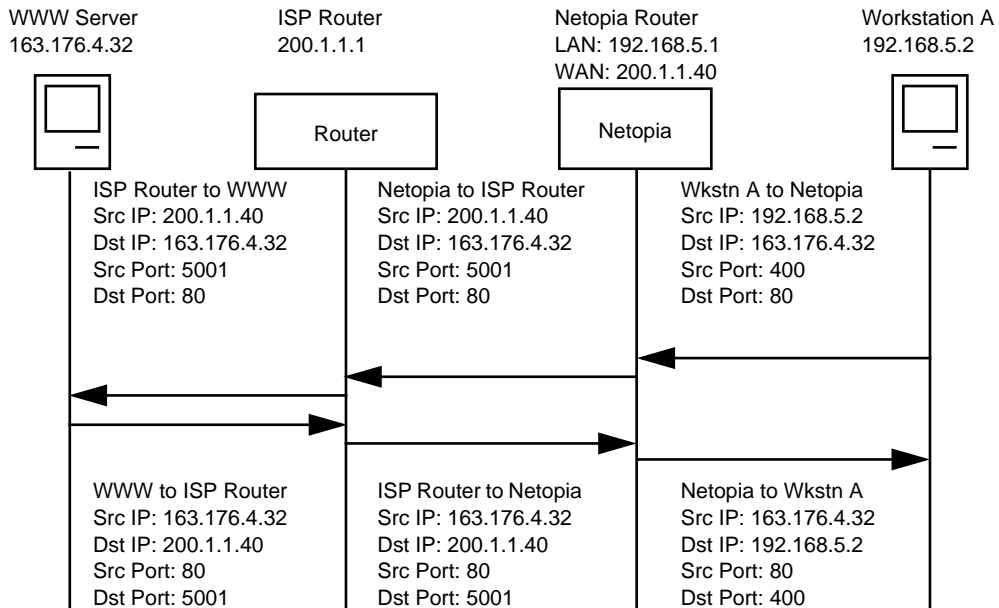

As you can see, the IP packet from Workstation A is sent to the Netopia R7200 and the source IP address is substituted with 200.1.1.40 and the source port is substituted with 5001, then the IP packet checksum is recalculated. When this modified packet reaches the WWW server on the Internet, the WWW server responds and sends the IP packet back to destination IP address 200.1.1.40 and destination port 5001.

When the Netopia R7200 receives this IP packet from the WWW server, the Netopia R7200 replaces the destination IP address with 192.168.5.2, the address for Workstation A. The port is changed back to 400, the IP packet checksum is recalculated, and the IP packet is sent to Workstation A on the Netopia R7200s LAN interface.

## C-4 User's Reference Guide

The reasons for the IP address changes are obvious from the preceding diagram, but what is not so obvious is why the TCP or UDP source ports need to be changed as well. These are changed and maintained in an internal table so the Netopia R7200 can determine which host on the local LAN interface sent the IP packet and what host the response from the WAN interface is going to go to on the LAN interface. This becomes especially important when two or more hosts on the LAN interface are accessing the same type of service on the Internet, like a WWW server (port 80), for example.

Now look at how two hosts on the LAN interface accessing the same WWW server on the Internet will work:

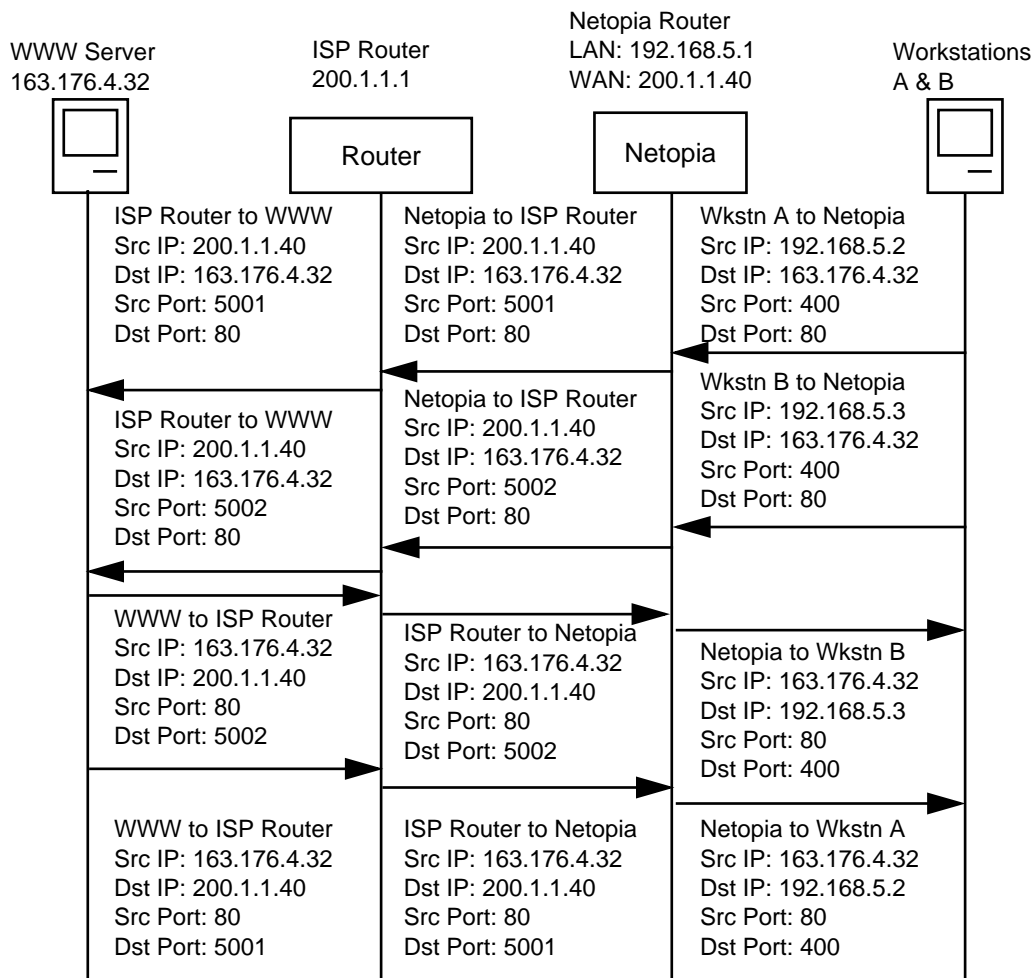

As you can see, when Workstation A and Workstation B transmit an IP packet to the WWW server on the Internet, they have unique source IP addresses on the LAN interface but potentially the same source ports, which in this case is 400. When the Netopia R7200 receives these packets, the source IP addresses are substituted with the single globally unique IP address that was acquired on the WAN interface, which is 200.1.1.40.



Now both IP packets have the exact same source IP address (200.1.1.40) and source ports (400). The Netopia R7200 is then able to distinguish between the two IP packets by changing the source TCP or UDP ports and keeping this information in an internal table. As seen above, the source port for Workstation A has been changed to 5001 and the source port for Workstation B has been changed to 5002.

If you were to look at the internal port mapping table that is maintained by the Netopia R7200, it would look similar to the following:

Source LAN IP	Source LAN Port	Remapped LAN Port
192.168.5.2	TCP 400	TCP 5001
192.168.5.3	TCP 400	TCP 5002

With this information the Netopia R7200 can determine the appropriate routing for an IP response from the Internet. In this case, when the WWW server responds with a destination port of 5001, the Netopia R7200 can see that this packet's destination on the local LAN interface is actually Workstation A at IP address 192.168.5.2. Likewise, with the response for port 5002, the Netopia R7200 can see that this packet's destination on the local LAN interface is actually Workstation B at IP address 192.168.5.3.

## *Exported services*

Note that this “automatic” port remapping and IP address substitution only works in one direction – for IP packets that originated on the LAN interface destined to the WAN interface and the Internet. In order for port remapping and IP address substitution to work in the other direction – that is, hosts on the Internet that want to originate an IP packet destined to a host on the Netopia R7200s LAN interface – a manual redirection of TCP or UDP ports as well as destination IP addresses within the Netopia R7200 is required. This manual port remapping and IP address substitution is accomplished by setting up exported services.

Exported services are essentially user-defined pointers for a particular type of incoming TCP or UDP service from the WAN interface to a host on the local LAN interface. This is necessary since the Netopia R7200 and thus the attached local LAN has only one IP presence on the WAN interface and Internet. Exported services allows the user to redirect one type of service – for example Port 21 (FTP) – to a single host on the local LAN interface. This will then allow the Netopia R7200 to redirect any packets coming in from the Internet with the defined destination TCP or UDP port of port 21 (FTP) to be redirected to a host on the local LAN interface.

For example, suppose the WWW server on the Internet with the IP address of 163.176.4.32 wants to access Workstation B on the Netopia R7200s local LAN interface which is operating as an FTP server. The IP address for Workstation B is 192.168.5.3, which is not a valid IP address, and thus the WWW server on the Internet cannot use this IP address to access Workstation B.

The WWW server on the Internet would then have to use the single valid IP address that was acquired on the Netopia R7200's WAN interface to access any host on the Netopia R7200's local LAN interface, since this is the only valid address for the Internet. But if the WWW server on the Internet opens a connection to 200.1.1.40 via port 21 (FTP) and no exported services are defined on the Netopia R7200, the Netopia R7200 will discard the incoming packet since the Netopia R7200 itself does not perform the requested service.

You can see why exported services are necessary. In the example above, an exported service needs to be defined within the Netopia R7200 redirecting any incoming IP traffic with a destination port of 21 to the host on the local LAN interface with the IP address of 192.168.5.3.

If the WWW server on the Internet then tries to open a connection to the IP address of 200.1.1.40 with the appropriate exported service defined, the Netopia R7200 will look at the destination port and will find that it is destined for port 21 (FTP). The Netopia R7200 then looks at the internal user-defined exported services table and finds that any incoming IP traffic from the WAN port with a destination of port 21 (FTP) should be redirected to the IP address of 192.168.5.3 on the local LAN interface, which in this case is Workstation B.

Once the appropriate exported services are defined, there can be seamless communication between a host on the Internet and a host on the Netopia R7200's local LAN interface.

### *Important notes*

Even with the advantages of NAT, there are several things you should note carefully:

- There is no formally agreed-upon method among router vendors for handling an all-zeros IPCP request. The majority of router vendors use the all-zeros IPCP request to determine when a dial-in host wants to be assigned an IP address. Some vendors however attempt to negotiate and establish routing with an all-zeros IP address. The Netopia R7200 will not allow routing to be established with an all-zeros IP address and the call will be dropped with an error logged in the Device Event History.
- When using NAT it is most likely that the Netopia R7200 will be receiving an IP address from a pool of dynamic IP addresses at the ISP. This means that the Netopia R7200's IP presence on the Internet will change with each connection. This can potentially cause problems with devices on the Internet attempting to access services like WWW and FTP servers or AURP partners on the Netopia R7200's local LAN interface. In this case, if a dynamic IP address is assigned to the WAN interface of the Netopia R7200 each time, the administrator of the Netopia R7200 will have to notify clients who want to access services on the Netopia R7200's LAN interface of the new IP address after each connection.
- With NAT enabled, there cannot be two or more of the same types of service accessible from the Internet on the LAN interface of the Netopia R7200. For example, there cannot be multiple FTP servers (Port 23) on the Netopia R7200's LAN interface that can be accessible by workstations on the Internet. This is because there is no way within the Netopia R7200 and IP to distinguish between multiple servers using the same port, in this case port 23.
- Fictional IP addresses may be assigned on the Netopia R7200's LAN interface. It is strongly recommended that for the Netopia R7200's LAN interface, an IP address from the Class C address range of 192.168.X.X be used. This is because this range is defined by the IANA as an address space that will never be routed through the Internet and is to be used by private Intranets not attached to the Internet.

If the address range of 192.168.X.X is not used and another range of addresses such as 100.1.1.X is used instead, this address space can potentially overlap an address space that is owned by a user attached to the Internet. Thus if a user on the Netopia R7200's LAN interface has an IP address of 100.1.1.2 while the Netopia R7200's LAN interface is 100.1.1.2 and the local host wants to access a host on the Internet with the address of 100.1.1.8, the Netopia R7200 has no way of knowing that the 200.1.1.8 address is actually on the Internet and not on its local LAN interface, since the local LAN interface is assigned the IP address range of 200.1.1.1 to 200.1.1.14.

---

## Configuration

NAT is enabled by default with the SmartStart configuration utility. You can toggle **Enable Address Translation** to **No** or **Yes** in the Connection Profile screen in System Configuration under the IP Profile Parameters section. NAT is enabled on a per-profile basis, so it is possible to have any combination of NAT and non-NAT profiles. An example of enabling NAT is as follows:

IP Profile Parameters	
Remote IP Address:	127.0.0.2
Remote IP Mask:	255.255.255.0
Address Translation Enabled:	Yes
Filter Set...	
Remove Filter Set	
Receive RIP:	No

Enter the remote IP network's IP address (form xxx.xxx.xxx.xxx decimal).  
Configure IP requirements for a remote network connection here.

Toggling **Address Translation Enabled** to **Yes** enables the Netopia R7200 to send out an all-zeros IPCP address that requests an IP to be assigned to the Netopia R7200's WAN interface. Note that the remote IP address is 127.0.0.2, which should also be the default gateway under IP Setup in System Configuration. This is done for profile matching purposes and because the IP address of the router the Netopia R7200 is dialing is not always known.

As mentioned earlier in this appendix, NAT works well for IP sessions originated on the Netopia R7200's LAN interface destined for the Internet without any additional configuration. For incoming IP connections from the Internet to a host on the Netopia R7200's LAN interface, exported services need to be used.

Exported services are configured under IP Setup in System Configuration. This is where a particular type of TCP or UDP service originating from the Internet is redirected to a host on the Netopia R7200's LAN interface. An example of this screen follows:

Add Exported Service	
Service...	+-Type-----Port--+
Local Server's IP Address:	ftp 21
	telnet 23
	smtp 25
	tftp 69
	gopher 70
	finger 79
	www-http 80
	pop2 109
	pop3 110
	snmp 161
	timbuktu 407
	pptp 1723
	irc 6667
	Other...

ADD EXPORT NOW CANCEL

Within exported services is a pop-up list of well-known TCP and UDP services that can be redirected to a single host on the Netopia R7200's LAN interface. There is also an **Other...** option that allows for manual configuration of additional TCP or UDP ports. A total of 32 exported services can be defined.

When a particular type of service is redirected to an IP address, that service is removed from the pop-up list, since only one type of service can be redirected to a single host. However several different types of services can be redirected to a single or multiple hosts. For example, port 80 (WWW server) could be redirected to 192.168.5.3 on the Netopia R7200's LAN interface, and port 23 (Telnet) can be redirected to that same host.

---

## Summary

NAT is a powerful feature of the Netopia R7200 and when used and set up properly can yield a secure network while only using one IP address on the WAN interface. Note that the addresses listed in this appendix are for demonstration purposes only. Do not use these addresses when configuring your local network.

# Appendix D

## Binary Conversion Table

This table is provided to help you choose subnet numbers and host numbers for IP and MacIP networks that use subnetting for IP addresses.

Decimal	Binary	Decimal	Binary	Decimal	Binary	Decimal	Binary
0	0	32	100000	64	1000000	96	1100000
1	1	33	1000001	65	1000001	97	1100001
2	10	34	100010	66	1000010	98	1100010
3	11	35	100011	67	1000011	99	1100011
4	100	36	100100	68	1000100	100	1100100
5	101	37	100101	69	1000101	101	1100101
6	110	38	100110	70	1000110	102	1100110
7	111	39	100111	71	1000111	103	1100111
8	1000	40	101000	72	1001000	104	1101000
9	1001	41	101001	73	1001001	105	1101001
10	1010	42	101010	74	1001010	106	1101010
11	1011	43	101011	75	1001011	107	1101011
12	1100	44	101100	76	1001100	108	1101100
13	1101	45	101101	77	1001101	109	1101101
14	1110	46	101110	78	1001110	110	1101110
15	1111	47	101111	79	1001111	111	1101111
16	10000	48	110000	80	1010000	112	1110000
17	10001	49	110001	81	1010001	113	1110001
18	10010	50	110010	82	1010010	114	1110010
19	10011	51	110011	83	1010011	115	1110011
20	10100	52	110100	84	1010100	116	1110100
21	10101	53	110101	85	1010101	117	1110101
22	10110	54	110110	86	1010110	118	1110110
23	10111	55	110111	87	1010111	119	1110111
24	11000	56	111000	88	1011000	120	1111000
25	11001	57	111001	89	1011001	121	1111001
26	11010	58	111010	90	1011010	122	1111010
27	11011	59	111011	91	1011011	123	1111011
28	11100	60	111100	92	1011100	124	1111100
29	11101	61	111101	93	1011101	125	1111101
30	11110	62	111110	94	1011110	126	1111110
31	11111	63	111111	95	1011111	127	1111111

*D-2 User's Reference Guide*

<b>Decimal</b>	<b>Binary</b>	<b>Decimal</b>	<b>Binary</b>	<b>Decimal</b>	<b>Binary</b>	<b>Decimal</b>	<b>Binary</b>
128	10000000	160	10100000	192	11000000	224	11100000
129	10000001	161	10100001	193	11000001	225	11100001
130	10000010	162	10100010	194	11000010	226	11100010
131	10000011	163	10100011	195	11000011	227	11100011
132	10000100	164	10100100	196	11000100	228	11100100
133	10000101	165	10100101	197	11000101	229	11100101
134	10000110	166	10100110	198	11000110	230	11100110
135	10000111	167	10100111	199	11000111	231	11100111
136	10001000	168	10101000	200	11001000	232	11101000
137	10001001	169	10101001	201	11001001	233	11101001
138	10001010	170	10101010	202	11001010	234	11101010
139	10001011	171	10101011	203	11001011	235	11101011
140	10001100	172	10101100	204	11001100	236	11101100
141	10001101	173	10101101	205	11001101	237	11101101
142	10001110	174	10101110	206	11001110	238	11101110
143	10001111	175	10101111	207	11001111	239	11101111
144	10010000	176	10110000	208	11010000	240	11110000
145	10010001	177	10110001	209	11010001	241	11110001
146	10010010	178	10110010	210	11010010	242	11110010
147	10010011	179	10110011	211	11010011	243	11110011
148	10010100	180	10110100	212	11010100	244	11110100
149	10010101	181	10110101	213	11010101	245	11110101
150	10010110	182	10110110	214	11010110	246	11110110
151	10010111	183	10110111	215	11010111	247	11110111
152	10011000	184	10111000	216	11011000	248	11111000
153	10011001	185	10111001	217	11011001	249	11111001
154	10011010	186	10111010	218	11011010	250	11111010
155	10011011	187	10111011	219	11011011	251	11111011
156	10011100	188	10111100	220	11011100	252	11111100
157	10011101	189	10111101	221	11011101	253	11111101
158	10011110	190	10111110	222	11011110	254	11111110
159	10011111	191	10111111	223	11011111	255	11111111

# Appendix E

## Further Reading

- Alexander, S. and R. Droms, *DHCP Options and BOOTP Vendor Extensions*, RFC 2131, Silicon Graphics, Inc., Bucknell University, PA, 1997.
- Angell, David, *ISDN for Dummies*, IDG Books Worldwide, Foster City, CA, 1995. Thorough introduction to ISDN for beginners.
- Apple Computer, Inc., *AppleTalk Network System Overview*, Addison-Wesley Publishing Company, Inc., Reading, MA, 1989.
- Apple Computer, Inc., *Planning and Managing AppleTalk Networks*, Addison-Wesley Publishing Company, Inc., Reading, MA, 1991.
- Asymmetric Digital Subscriber Line (ADSL) Forum, *Framing and Encapsulation Standards for ADSL: Packet Mode*, TR-003, 1997.
- Black, U., *Data Networks: Concepts, Theory and Practice*, Prentice Hall, Englewood Cliffs, NJ, 1989.
- Black, U., *Physical Level Interfaces and Protocols*, IEEE Computer Society Press, Los Alamitos, CA, 1988.
- Black, U., *Emerging Communications Technologies*, PTR Prentice Hall, Englewood Cliffs, NJ, 1994. Describes how emerging communications technologies, including ISDN and Frame Relay, operate and where they fit in a computer/communications network.
- Bradley, T., C. Brown and A. Malis, *Multiprotocol Interconnect over Frame Relay*, Network Working Group, Internet Engineering Task Force, RFC 1490, 1993.
- Case, J.D., J.R. Davins, M.S. Fedor, and M.L. Schoffstall, *Introduction to the Simple Gateway Monitoring Protocol*, IEEE Network, March 1988.
- Case, J.D., J.R. Davins, M.S. Fedor, and M.L. Schoffstall, *Network Management and the Design of SNMP, ConneXions: The Interoperability Report*, Vol. 3, March 1989.
- Chapman, D. Brent, *Network (In)Security Through IP Packet Filtering*, Great Circle Associates, Mountain View, CA.
- Chapman, D. Brent, and Elizabeth D. Zwicky, *Building Internet Firewalls*, O'Reilly & Associates, Sebastopol, CA, 1995. Dense and technical, but Chapter 6 provides a basic introduction to packet filtering.
- Chappell, L., *Novell's Guide to NetWare LAN Analysis*, Novell Press, San Jose, CA, 1993.
- Clark, W., *SNA Internetworking, ConneXions: The Interoperability Report*, Vol. 6, No. 3: March 1992.
- Comer, D.E., *Internetworking with TCP/IP: Principles, Protocols, and Architecture* Vol. I, 2nd ed., Prentice Hall, Englewood Cliffs, NJ, 1991.
- Copper Mountain Networks, Internal Control Protocol (ICP) Interface Control Document (ICD), January 5, 1998.
- Davidson, J., *An Introduction to TCP/IP*, Springer-Verlag, New York, NY, 1992.
- Droms, R., *Dynamic Host Configuration Protocol*, RFC 2131, Bucknell University, PA, 1997.
- Ferrari, D., *Computer Systems Performance Evaluation*, Prentice Hall, Englewood Cliffs, NJ, 1978.

## **E-2 User's Reference Guide**

- Garcia-Luna-Aceves, J.J., *Loop-Free Routing Using Diffusing Computations*, IEEE/ACM Transactions on Networking, Vol. 1, No. 1, 1993.
- Garfinkel, Simson., *PGP: Pretty Good Privacy*, O'Reilly & Associates, Sebastopol, CA, 1991. A guide to the free data encryption program PGP and the issues surrounding encryption.
- Green, J.K., *Telecommunications*, 2nd ed., Business One Irwin, Homewood, IL, 1992.
- Heinanen, J., *Multiprotocol Encapsulation over ATM Adaptation Layer 5*, RFC 1483, July 1993.
- Jones, N.E.H., and D. Kosiur., *MacWorld Networking Handbook*, IDG Books Worldwide, Inc., San Mateo, CA, 1992.
- Kousky, K., *Bridging the Network Gap, LAN Technology*, Vol. 6, No. 1, January 1990.
- LaQuey, Tracy, *The Internet Companion: A Beginner's Guide to Global Networking*, Addison-Wesley Publishing Company, Reading, MA, 1994.
- Leinwand, A., and K. Fang, *Network Management: A Practical Perspective*, Addison-Wesley Publishing Company, Reading, MA, 1993.
- Levine, John R., and Carol Baroudi, *The Internet for Dummies*, IDG Books Worldwide, Foster City, CA, 1993. Covers all of the most popular Internet services, including e-mail, newsgroups, and the World Wide Web. Also has information on setting up individual workstations with TCP/IP stacks.
- Lippis, N., *The Internetwork Decade, Data Communications*, Vol. 20, No. 14: October 1991.
- McNamara, J.E., *Local Area Networks*. Digital Press, Educational Services, Digital Equipment Corporation, Bedford, MA 01730.
- Malamud, C., *Analyzing Novell Networks*, Van Nostrand Reinhold, New York, NY, 1991.
- Malamud, C., *Analyzing Sun Networks*, Van Nostrand Reinhold, New York, NY, 1991.
- Martin, J., *SNA: IBM's Networking Solution*, Prentice Hall, Englewood Cliffs, NJ, 1987.
- Martin, J., with K.K. Chapman and the ARBEN Group, Inc., *Local Area Networks: Architectures and Implementations*, Prentice Hall, Englewood Cliffs, NJ, 1989.
- Miller, A. Mark, *Analyzing Broadband Networks (Frame Relay, SMDS, & ATM)*, M&T Books, San Mateo, CA, 1994. An intermediate/advanced reference on Frame Relay technologies.
- Miller, M.A., *Internetworking: A Guide to Network Communications LAN to LAN; LAN to WAN*, 2nd. ed., M&T Books, San Mateo, CA, 1992.
- Miller, M.A., *LAN Protocol Handbook*, M&T Books, San Mateo, CA, 1990.
- Miller, M.A., *LAN Troubleshooting Handbook*, M&T Books, San Mateo, CA, 1989.
- Perlman, R., *Interconnections: Bridges and Routers*, Addison-Wesley Publishing Company, Reading, MA, 1992.
- Rose, M.T., *The Open Book: A Practical Perspective on OSI*, Prentice Hall, Englewood Cliffs, NJ, 1990.
- Rose, M.T., *The Simple Book: An Introduction to Management of TCP/IP-based Internets*, Prentice Hall, Englewood Cliffs, NJ, 1991.
- Schwartz, M., *Telecommunications Networks: Protocols, Modeling, and Analysis*, Addison-Wesley Publishing Company, Reading, MA, 1987.
- Sherman, K., *Data Communications: A User's Guide*, Prentice Hall, Englewood Cliffs, NJ, 1990.



- Sidhu, G.S., R.F. Andrews, and A.B. Oppenheimer, *Inside AppleTalk*, 2nd ed., Addison-Wesley Publishing Company, Reading, MA, 1990.
- Siyam, Karanjit, *Internet Firewall and Network Security*, New Riders Publishing, Indianapolis, IN, 1995. Similar to the Chapman and Zwicky book.
- Smith, Philip, *Frame Relay Principles and Applications*, Addison-Wesley Publishing Company, Reading, MA, 1996. Covers information on Frame Relay, including the pros and cons of the technology, description of the theory and application, and an explanation of the standardization process.
- Spragins, J.D., et al., *Telecommunications Protocols and Design*, Addison-Wesley Publishing Company, Reading, MA, 1991.
- Stallings, W., *Data and Computer Communications*, Macmillan Publishing Company, New York, NY, 1991.
- Stallings, W., *Handbook of Computer-Communications Standards*, Vols. 1–3, Howard W. Sams, Carmel, IN, 1990.
- Stallings, W. *Local Networks*, 3rd ed., Macmillan Publishing Company, New York, NY, 1990.
- Stevens, W.R., *TCP/IP Illustrated*, Vol 1, Addison-Wesley Publishing Company, Reading, MA, 1994.
- Sunshine, C.A. (ed.), *Computer Network Architectures and Protocols*, 2nd ed., Plenum Press, New York, NY, 1989.
- Tannenbaum, A.S., *Computer Networks*, 2nd ed., Prentice Hall, Englewood Cliffs, NJ, 1988.
- Terplan, K., *Communication Networks Management*, Prentice Hall, Englewood Cliffs, NJ, 1992.
- Tsuchiya, P., *Components of OSI: IS-IS Intra-Domain Routing*, *ConneXions: The Interoperability Report*, Vol. 3, No. 8: August 1989.
- Tsuchiya, P., *Components of OSI: Routing (An Overview)*, *ConneXions: The Interoperability Report*, Vol. 3, No. 8: August 1989.
- Zimmerman, H., *OSI Reference Model—The ISO Model of Architecture for Open Systems Interconnection*, *IEEE Transactions on Communications COM-28*, No. 4: April 1980.



# Appendix F

## Technical Specifications and Safety Information

### Pinouts for Auxiliary port modem cable

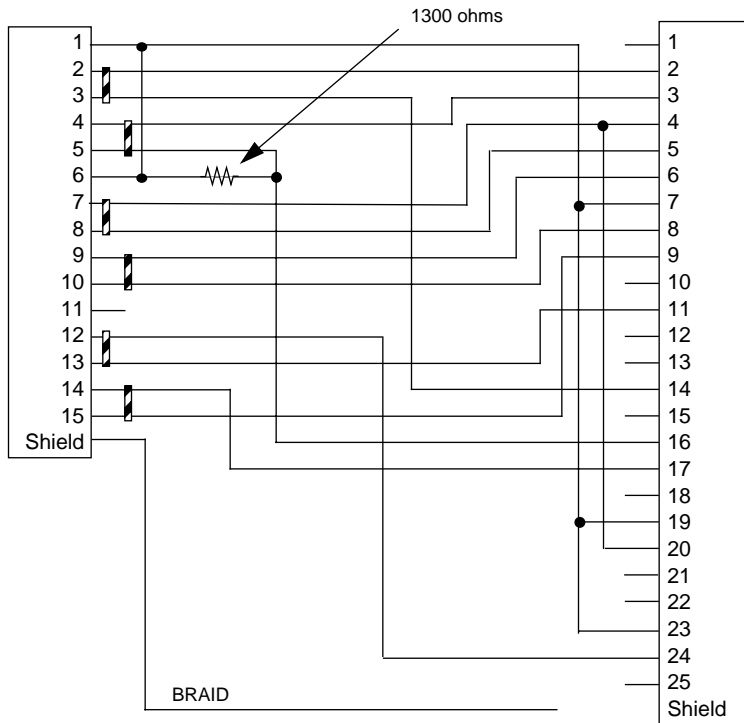

HD-15		DB-25	
Pin 1	Ground	Pin 1	(not used)
Pin 2	TDA	Pin 2	TD
Pin 3	TDB	Pin 3	RD
Pin 4	RDA	Pin 4	RTS
Pin 5	RDB	Pin 5	CTS
Pin 6	(not used)	Pin 6	DCE Ready
Pin 7	DTR	Pin 7	Ground
Pin 8	CTS	Pin 8	RLSD

HD-15		DB-25	
Pin 9	DSR	Pin 9	-RSET (EIA-530)
Pin 10	DCD	Pin 10	(not used)
Pin 11	(not used)	Pin 11	-TSET (EIA-530)
Pin 12	TCA	Pin 12	(not used)
Pin 13	TCB	Pin 13	(not used)
Pin 14	RCA	Pin 14	-TD (EIA-530) STD (EIA-232)
Pin 15	RCB	Pin 15	(not used)
		Pin 16	-RD (EIA-530) SRD (EIA-232)
		Pin 17	RSET
		Pin 18	(not used)
		Pin 19	-RTS (EIA-530) SRTS (EIA-232)
		Pin 20	DTE Ready
		Pin 21	(not used)
		Pin 22	(not used)
		Pin 23	Ground
		Pin 24	TSET
		Pin 25	(not used)

**Note:** Certain RS-232 modems do not properly accept signals on pins 12/24, 13/11, 14/17, and 15/9. For these applications, these pins may need to be cut.

---

## Description

**Dimensions:** 124.0 cm (w) x 20.0 cm (d) x 5.3 cm (h)  
9.4" (w) x 7.9" (d) x 2.1" (h)

**Communications interfaces:** The Netopia R7200 SDSL Router has an RJ-45 jack for SDSL line connections; an 8-port 10Base-T Ethernet hub for your LAN connection; a DB-9 Console port; and an HD-15 Auxiliary port that can be used as either a serial or LocalTalk port.

## Power requirements

- 12 VDC input
- 1.5 amps

## Environment

**Operating temperature:** 0° to +40° C

**Storage temperature:** 0° to +70° C

**Relative storage humidity:** 20 to 80% noncondensing

## *Software and protocols*

**Software media:** Software preloaded on internal flash memory; field upgrades done via download to internal flash memory via XMODEM or TFTP

**Routing:** TCP/IP Internet Protocol Suite, RIP, AppleTalk\*, LocalTalk-to-Ethernet routing\*, AURP tunneling\*, MacIP\*, IPX

\* Optional add-on feature

**WAN support:** SDSL

**Security:** IP/IPX firewalls, UI password security, PAP, CHAP, PAP-TOKEN, CACHE-TOKEN

**SNMP network management:** SNMPv1, MIB-II (RFC 1213), Interface MIB (RFC 1229), Ethernet MIB (RFC 1643), AppleTalk MIB-I (1243), Netopia R7200 MIB

**Management/configuration methods:** HTTP (Web server), serial console, remote modem console, Telnet, SNMP

**Diagnostics:** Ping, event logging, routing table displays, trace route, statistics counters, web-based management

## *Agency approvals*

### *North America*

Safety Approvals:

- United States – UL: 1950 Third Edition
- Canada – CSA: CAN/CSA-C22.2 No. 950-95

EMI:

- FCC Class B

### *International*

Safety Approvals:

- Low Voltage (European directive) 72/23
- EN60950 (Europe)
- ETSI 300 047 (Europe)
- AS/NRZ 3260 (Australia)
- TS001(Australia)
- TS008 (Australia)

EMI Compatibility:

- 89/336/EEC (European directive)
- EN55022:1994 CISPR22 Class B
- EN550082-1:1992 (Immunity)

## *Regulatory notices*

### *Warning*

This is a Class B product. In a domestic environment this product may cause radio interference, in which case the user may be required to take adequate measures. Adequate measures include increasing the physical distance between this product and other electrical devices.

**United States.** This equipment has been tested and found to comply with the limits for a Class B digital device, pursuant to Part 15 of the FCC Rules. These limits are designed to provide reasonable protection against harmful interference when the equipment is operated in a commercial environment. This equipment generates, uses, and can radiate radio frequency energy and, if not installed and used in accordance with the instruction manual, may cause harmful interference to radio communications. Operation of this equipment in a residential area is likely to cause harmful interference in which case the user will be required to correct the interference at his own expense. Operation is subject to the following two conditions: (1) this device may not cause harmful interference, and (2) this device must accept any interference received, including interference that may cause undesired operation.

**Service requirements.** In the event of equipment malfunction, all repairs should be performed by our Company or an authorized agent. Under FCC rules, no customer is authorized to repair this equipment. This restriction applies regardless of whether the equipment is in or out of warranty. It is the responsibility of users requiring service to report the need for service to our Company or to one of our authorized agents. Service can be obtained at Netopia, Inc., 2470 Mariner Square Loop, Alameda, California, 94501.

### ***Important***

This product was tested for FCC compliance under conditions that included the use of shielded cables and connectors between system components. Changes or modifications to this product not authorized by the manufacturer could void your authority to operate the equipment.

**Canada.** This digital apparatus does not exceed the Class B limits for radio noise emission from digital apparatus set out in the Radio Interference Regulations of the Canadian Department of Communications.

Le présent appareil numérique n'émet pas de bruits radioélectriques dépassant les limites applicables aux appareils numériques de la classe A prescrites dans le Règlement sur le brouillage radioélectrique édicté par le ministère des Communications du Canada.

### ***Declaration for Canadian users***

The Canadian Industry Canada label identifies certified equipment. This certification means that the equipment meets certain telecommunications network protective, operation, and safety requirements. The Department does not guarantee the equipment will operate to the user's satisfaction.

Before installing this equipment, users should ensure that it is permissible to be connected to the facilities of the local telecommunications company. The equipment must also be installed using an acceptable method of connection. In some cases, the company's inside wiring associated with a single line individual service may be extended by means of a certified connector assembly (telephone extension cord). The customer should be aware that compliance with the above conditions may not prevent degradation of service in some situations.

Repairs to the certified equipment should be made by an authorized Canadian maintenance facility designated by the supplier. Any repairs or alterations made by the user to this equipment or equipment malfunctions may give the telecommunications company cause to request the user to disconnect the equipment.

Users should ensure for their own protection that the electrical ground connections of the power utility, telephone lines, and internal metallic water pipe system, if present, are connected together. This precaution may be particularly important in rural areas.

### ***Caution***

Users should not attempt to make such connections themselves, but should contact the appropriate electric inspection authority, or electrician, as appropriate.

The load number (LN) assigned to each terminal device denotes the percentage of the total load to be connected to a telephone loop that is used by the device to prevent overloading. The termination on a loop may consist of any combination of devices subject only to the requirement that the total of the load numbers of all the devices does not exceed 100.

## ***Important safety instructions***

### ***Caution***

- The direct plug-in power supply serves as the main power disconnect; locate the direct plug-in power supply

## ***F-6 User's Reference Guide***

near the product for easy access.

- For use only with CSA Certified Class 2 power supply, rated 12VDC, 1.5A.

### ***Telecommunication installation cautions***

- Never install telephone wiring during a lightning storm.
- Never install telephone jacks in wet locations unless the jack is specifically designed for wet locations.
- Never touch uninsulated telephone wires or terminals unless the telephone line has been disconnected at the network interface.
- Use caution when installing or modifying telephone lines.
- Avoid using a telephone (other than a cordless type) during an electrical storm. There may be a remote risk of electric shock from lightning.
- Do not use the telephone to report a gas leak in the vicinity of the leak.

### ***Battery***

The Netopia R7200's lithium battery is designed to last for the life of the product. The battery is not user-serviceable.

### ***Caution!***

Danger of explosion if battery is incorrectly replaced.

Replace only with the same or equivalent type recommended by the manufacturer. Dispose of used batteries according to the manufacturer's instructions.



## Appendix G

### About SDSL

The Netopia R7200 SDSL Router (Symmetric Digital Subscriber Line) technology uses standard copper phone lines to send a digital signal between two points. Because the signal stays digital and does not go through the public switched telephone network SDSL allows a much faster data connection. Offering the same data rate in both directions, the SDSL Router provides symmetric bandwidth needed for business applications such as e-mail, file transfer, web browsing, corporate Intranet access, web hosting, and remote LAN access. The SDSL Router improves businesses productivity and competitiveness by providing cost effective, high speed Internet access over ordinary copper phone lines. SDSL creates a point-to-point link over a single copper wire so bandwidth isn't shared by anyone outside the remote office.

SDSL will allow you to connect to the Internet at a minimum of 128Kbps bi-directional, up to 1.568Mbps. Your LAN will constantly be connected and you will not have to dial into the Internet. DSL utilizes more of the bandwidth on copper phone lines than what is currently used for plain old telephone service (POTS). By utilizing frequencies between 26 kHz and 1MHz, DSL can encode more data to achieve higher data rates than would otherwise be possible in the restricted frequency range of a POTS network (up to 4 kHz). In order to utilize the frequencies above the voice audio spectrum, DSL equipment must be installed on both ends and the copper wire in between must be clean enough to sustain the higher frequencies for the entire route. This means that bandwidth limiting devices such as loading coils can prevent DSL from being used.

SDSL is more appropriate for business users because bandwidth is the same in both directions. Asymmetric DSL Service is better suited for individual consumers who generally require more speed in the download stream (web surfing) with little data going in the other direction.

Netopia's SDSL router has fewer implementation issues than ADSL routers. It uses 2B1Q line encoding (same as T1 or ISDN) and this doesn't produce the same noise and interference as ADSL, which uses DMT or CAP encoding. In some cases the phone company may refuse to provision ADSL service due to crosstalk with other voice and data lines bundled in the same cable.

Historically, HDSL has been primarily used to deploy repeaterless T1 and E1 services in areas where repeater installation was costly or problematic. Today there are over 300,000 such lines installed in the U.S. While these implementations typically require two or three pairs of copper wire, a new form of HDSL has emerged that uses a single pair of copper (i.e., SDSL) but still delivers up to 2 Mbps of symmetrical bandwidth depending on loop length and quality.

Single pair HDSL (S-HDSL or SDSL) offers workable solutions to several of the challenges faced today by its less mature cousin, ADSL. Both technologies will have their place in the service provider's network, and that will be based on the specific customer applications that are supported over the last mile connection. However, SDSL offers some very attractive solutions to today's main drivers—remote data connectivity for corporate or Internet applications.

Because SDSL uses the same technology as the market-proven HDSL, it benefits from the maturity of HDSL implementations. For example, SDSL silicon chipsets cost about a third of that for ADSL chipsets. The lower per line cost means service providers can launch high speed data services sooner rather than later.

Higher speed ADSL solutions can then be brought on line when they are more cost effective.

The maturity of SDSL silicon also includes an advantage in the area of power consumption. Where most ADSL implementations require 6-8 watts of power, current SDSL modems consume 4 watts of power or less.

## ***G-2 User's Reference Guide***

Because over 300,000 lines are already deployed using HDSL, service providers feel comfortable with SDSL since it uses the same technology as its predecessor and ISDN. The line coding employed by both HDSL and ISDN has not caused any interference with existing services like T1. This means service providers deploy SDSL solutions without worry about impact on other services in neighboring binder groups.

# Glossary

**access line:** A telephone line reaching from the telephone company central office to a point usually on your premises. Beyond this point the wire is considered inside wiring.

**analog:** In telecommunications, telephone transmission and/or switching that is not digital. An analog phone transmission is one that was originally intended to carry speech or voice, but may with appropriate modifications be used to carry data of other types.

**ANSI (American National Standards Institute):** Devises and proposes recommendations for international communications standards. See also *CCITT*.

**AppleTalk:** A comprehensive network system designed and developed by Apple Computer, Inc. AppleTalk allows many different types of computer systems, printers, and servers to communicate on a variety of cabling schemes, including LocalTalk and Ethernet cabling. In this manual, AppleTalk refers especially to the protocols or rule sets that govern this communication.

**AppleTalk address:** A unique identifier for each device using AppleTalk that allows information to be sent and received correctly. An AppleTalk address always includes a network number wherever two or more AppleTalk networks are connected together by routers.

**AURP (Apple Update-based Router Protocol):** An enhanced AppleTalk routing protocol. AURP provides improved support for AppleTalk over wide area networks (WANs) and tunneling through non-AppleTalk (IP) networks. AURP features include network number remapping, clustering of remote network numbers, and hop count reduction.

**backbone:** A network topology consisting of a single length of cable with multiple network connection points.

**bandwidth:** The range of frequencies, expressed in Kilobits per second, that can pass over a given data transmission channel within a network. The bandwidth determines the rate at which information can be sent through a channel - the greater the bandwidth, the more information that can be sent in a given amount of time.

**BAP (Bandwidth Allocation Protocol):** Protocol that manages the dynamic bandwidth allocation of implementations supporting the PPP Multilink protocol. This is done by defining the Bandwidth Allocation Protocol (BAP), as well as its associated control protocol, the Bandwidth Allocation Control Protocol (BACP). BAP can be used to manage the number of links in a multilink bundle.

**baud rate:** The rate of the signaling speed of a transmission medium.

**bit:** A binary digit; the smallest unit of data in the binary counting system. A bit has a value of either 0 or 1.

**bits per second (bps):** A measure of the actual data transmission rate. The bps rate may be equal to or greater than the baud rate, depending on the modulation technique used to encode bits into each baud interval. The correct term to use when describing modem data transfer speeds.

**bps:** See *bits per second*.

**branch:** A length of cable in a star network that goes from the center of the star to a wall jack.

**broadcast:** A network transaction that sends data to all hosts connected to the network.

**burstiness:** Data that uses bandwidth only sporadically; that is, information that does not use the total bandwidth of a circuit 100 percent of the time. During pauses, channels are idle, and no traffic flows across them in either direction. Interactive and LAN-to-LAN data is bursty in nature, because it is sent intermittently, and between data transmissions the channel experiences idle time waiting for the DTEs to respond to transmitted data user's input and waiting for the user to send more data.

## 2 User's Reference Guide

**byte:** A group of bits, normally eight, which represent one data character.

**CallerID:** See *CND*.

**CCITT (Comite Consultatif International Telegraphique et Telephonique):** International Consultative Committee for Telegraphy and Telephony, a standards organization that devises and proposes recommendations for international communications. See also *ANSI (American National Standards Institute)*.

**CHAP (Challenge Handshake Protocol):** A method for ensuring secure network access and communications.

**Class A, B, and C networks:** The values assigned to the first few bits in an IP network address determine which class designation the network has. In decimal notation, Class A network addresses range from 1.X.X.X to 126.X.X.X, Class B network addresses range from 128.1.X.X to 191.254.X.X, and Class C addresses range from 192.0.1.X to 223.255.254.X. For more information on IP network address classes, see [Appendix B, "Understanding IP Addressing."](#)

**client:** An intelligent workstation that makes requests to other computers known as servers. PC computers on a LAN can be clients.

**clustering:** A feature that clusters remapped network numbers into a range of sequential network numbers.

**CNA (Calling Number Authentication):** A security feature that will reject an incoming call if it does not match the Calling Number field in one of the Netopia ISDN Router's connection profiles.

**CND (Calling Number Delivery):** Also known as caller ID, a feature that allows the called customer premises equipment (CPE) to receive a calling party's directory number during the call establishment phase.

**community strings:** Sequences of characters that serve much like passwords for devices using SNMP. Different community strings may be used to allow an SNMP user to gather device information or change device configurations.

**CRC (Cyclic Redundancy Check):** A computational means to ensure the integrity of a block of data. The mathematical function is computed, before the data is transmitted at the originating device. Its numerical value is computed based on the content of the data. This value is compared with a recomputed value of the function at the destination device.

**DCE (Data Communications Equipment):** Term defined by standards committees that applies to communications equipment, typically modems or printers, as distinct from other devices that attach to the network, typically personal computers or data terminals (DTE). The distinction generally refers to which pins in an RS-232-C connection transmit or receive data. Also see *DTE*.

**DDP (Datagram Delivery Protocol):** Defines socket-to-socket delivery of datagrams over an AppleTalk internet.

**default zone:** When a Phase II EtherTalk network includes more than one zone, all routers on that network must be configured to assign one of these zones as a default zone. The default zone is temporarily assigned to any Phase II EtherTalk node that hasn't chosen a zone. The user may choose another zone by opening the Network Control Panel, selecting the correct physical connection, and then choosing a zone in the scrolling field displayed.

**DHCP (Dynamic Host Configuration Protocol):** A service that lets clients on a LAN request configuration information, such as IP host addresses, from a server.

**DNS (Domain Name Service):** A TCP/IP protocol for discovering and maintaining network resource information distributed among different servers.

**download:** The process of transferring a file from a server to a client.

**DTE (Data Terminal Equipment):** Term defined by standards committees, that applies to communications equipment, typically personal computers or data terminals, as distinct from other devices that attach to the network, typically modems or printers (DCE). The distinction generally refers to which pins in an RS-232-C connection transmit or receive data. Pins 2 and 3 are reversed. Also see *DCE*.

**EIA (Electronic Industry Association):** A North American standards association.

**Ethernet:** A networking protocol that defines a type of LAN characterized by a 10 Mbps (megabits per second) data rate. Ethernet is used in many mainframe, PC, and UNIX networks, as well as for EtherTalk.

**Ethernet address:** Sometimes referred to as a hardware address. A 48-bits long number assigned to every Ethernet hardware device. Ethernet addresses are usually expressed as 12-character hexadecimal numbers, where each hexadecimal character (0 through F) represents four binary bits. Do not confuse the Ethernet address of a device with its network address.

**EtherTalk:** Apple's data-link software that allows an AppleTalk network to be connected by Ethernet cables. EtherTalk is a protocol within the AppleTalk protocol set. Two versions of EtherTalk are in common use, designated as Phase I and Phase II EtherTalk.

**extended network:** A network using AppleTalk Phase II protocols; EtherTalk 2.0 and TokenTalk are extended networks. LocalTalk networks are compatible with Phase II but are not extended because a single LocalTalk network cannot have multiple network numbers or multiple zone names.

**firmware:** System software stored in a device's memory that controls the device. The Netopia ISDN Router's firmware can be updated.

**gateway:** A device that connects two or more networks that use different protocols. Gateways provide address translation services, but do not translate data. Gateways must be used in conjunction with special software packages that allow computers to use networking protocols not originally designed for them.

**hard seeding:** A router setting. In hard seeding, if a router that has just been reset detects a network number or zone name conflict between its configured information and the information provided by another router, it disables the router port for which there is a conflict. See also *non-seeding*, *seeding*, *seed router*, and *soft seeding*.

**HDLC (High-Level Data Link Control):** A generic link-level communications protocol developed by the International Organization for Standardization (ISO). HDLC manages synchronous, code-transparent, serial information transfer over a link connection. See also *SDLC (Synchronous Data Link Control)*.

**header:** In packets, a header is part of the envelope information that surrounds the actual data being transmitted. In e-mail, a header is usually the address and routing information found at the top of messages.

**hop:** A single traverse from one node to another on a LAN.

**hop count:** The number of nodes (routers or other devices) a packet has gone through. If there are six routers between source and destination nodes, the hop count for the packet will be six when it arrives at its destination node. The maximum allowable hop count is usually 15.

**hop count reduction:** A feature of AURP supported by the Netopia ISDN Router. Tunnels and point-to-point links over WANs can often exceed the maximum allowable hop count of 15 routers. Network administrators can use the hop count reduction feature to set up tunnels and point-to-point links that exceed the 15-router limit.

**host:** A single, addressable device on a network. Computers, networked printers, and routers are hosts.

**host computer:** A communications device that enables users to run applications programs to perform such functions as text editing, program execution, access to data bases, etc.

#### 4 User's Reference Guide

**internet:** A set of networks connected together by routers. This is a general term, not to be confused with the large, multi-organizational collection of IP networks known as the Internet. An internet is sometimes also known as an internetwork.

**internet address, IP address:** Any computing device that uses the Internet Protocol (IP) must be assigned an internet or IP address. This is a 32-bit number assigned by the system administrator, usually written in the form of 4 decimal fields separated by periods, e.g., 192.9.200.1. Part of the internet address is the IP network number (IP network address), and part is the host address (IP host address). All machines on a given IP network use the same IP network number, and each machine has a unique IP host address. The system administrator sets the subnet mask to specify how much of the address is network number and how much is host address. See also *Class A, B, and C networks*.

**IP (Internet Protocol):** A networking protocol developed for use on computer systems that use the UNIX operating system. Often used with Ethernet cabling systems. In this manual, IP is used as an umbrella term to cover all packets and networking operations that include the use of the Internet Protocol. See also *TCP/IP*.

**IP address, IP host address, IP network address:** See *internet address*.

**IP broadcast:** See *broadcast*.

**IP tunneling:** See *AURP*.

**IPX (Internet Packet Exchange):** A protocol used by Novell NetWare networks.

**ISDN (Integrated Services Digital Network):** A method of transmitting data digitally over telephone lines.

**ISP (Internet service provider):** A company that provides Internet-related services. Most importantly, an ISP provides Internet access services and products to other companies and consumers.

**ITU (International Telecommunication Union):** United Nations specialized agency for telecommunications. Successor to CCITT.

**LAN (local area network):** A privately owned network that offers high-speed communications channels to connect information processing equipment in a limited geographic area.

**LocalTalk:** The cabling specification for AppleTalk running at a speed of 230.4 kbps (kilobits per second).

**MacIP:** A protocol in which IP packets are encapsulated within AppleTalk headers, for transmission over AppleTalk networks. MacIP requires the presence of at least one AppleTalk-IP gateway. MacIP is usually used to allow an AppleTalk computer to communicate with an IP computer.

**MacIP client:** A Macintosh computer that is using the MacIP protocol to communicate with an IP computer.

**MIB (management information base):** A standardized structure for SNMP management information.

**modem:** A device used to convert digital signals from a computer into analog signals that can be transmitted across standard analog (not ISDN) telephone lines. Modem is a contraction of modulator-demodulator.

**NAT (Network Address Translation):** A feature that allows communication between the LAN connected to the Netopia ISDN Router and the Internet using a single IP address, instead of having a separate IP address for each computer on the network.

**NetBIOS:** A network communications protocol used on PC LANs.

**network:** A group of computer systems and other computer devices that communicate with one another.

**network administrator:** A person who coordinates the design, installation, and management of a network. A network administrator is also responsible for troubleshooting and for adding new users to the network.

**network log:** A record of the names of devices, location of wire pairs, wall-jack numbers, and other information about the network.

**network number:** A unique number for each network in an internet. AppleTalk network numbers are assigned by seed routers, to which the network is directly connected. An isolated AppleTalk network does not need a network number.

**network number remapping:** Resolves network number conflicts when two or more AppleTalk networks that may have duplicate network numbers are connected together. The Netopia ISDN Router lets you set up a range of network numbers into which remote AppleTalk network numbers are remapped.

**network range:** A unique set of contiguous numbers associated with an extended network; each number in a network range can be associated with up to 253 node addresses.

**node:** See *host*.

**non-seeding:** A router setting that causes it to request network number and zone information from any other routers on the network connected to the non-seeding port. If it receives this information, it begins to route packets through that port. See also *hard seeding*, *seeding*, *seed router*, and *soft seeding*.

**packet:** A group of fixed-length binary digits, including the data and call control signals, that are transmitted through an X.25 packet-switching network as a composite whole. The data, call control signals, and possible error control information are arranged in a predetermined format. Packets do not always travel the same pathway but are arranged in proper sequence at the destination side before forwarding the complete message to an addressee.

**packet-switching network:** A telecommunications network based on packet-switching technology, wherein a transmission channel is occupied only for the duration of the transmission of the packet.

**PAP (PPP authentication protocol):** A method for ensuring secure network access.

**parameter:** A numerical code that controls an aspect of terminal and/or network operation. Parameters control such aspects as page size, data transmission speed, and timing options.

**port:** A location for passing data in and out of a device, and, in some cases, for attaching other devices or cables.

**port number:** A number that identifies a TCP/IP-based service. Telnet, for example, is identified with TCP port 23.

**POTS (plain old telephone service):** Ordinary analog telephone service such as that used for voice transmission, as distinct from digital service.

**PPP (Point-to-Point Protocol):** A protocol for framing IP packets and transmitting them over a serial line.

**protocol:** A set of rules for communication, sometimes made up of several smaller sets of rules also called protocols. AppleTalk is a protocol that includes the LocalTalk, EtherTalk, and TokenTalk protocols.

**remapping:** See *network number remapping*.

**RFC (Request for Comment):** A series of documents used to exchange information and standards about the Internet.

**RIP (Routing Information Protocol):** A protocol used for the transmission of IP routing information.

**RJ-11:** A telephone-industry standard connector type, usually containing four pins.

**RJ-45:** A telephone-industry standard connector type usually containing eight pins.

**router:** A device that supports network communications. A router can connect identical network types, such as LocalTalk-to-LocalTalk, or dissimilar network types, such as LocalTalk-to-Ethernet. However—unless a gateway is available—a common protocol, such as TCP/IP, must be used over both networks. Routers may be equipped to provide WAN line support to the LAN devices they serve. They may also provide various management and monitoring functions as well as a variety of configuration capabilities.

**router port:** A physical or logical connection between a router and a network. Where a network only allows the use of one protocol, each physical connection corresponds to one logical router port. An example is the Netopia ISDN Router's LocalTalk port. Where a network allows the use of several protocols, each physical connection may correspond to several logical router ports—one for each protocol used. Each router port has its own network address.

**routing table:** A list of networks maintained by each router on an internet. Information in the routing table helps the router determine the next router to forward packets to.

**SDLC (Synchronous Data Link Control):** A link-level communications protocol used in an International Business Machines (IBM) Systems Network Architecture (SNA) network that manages synchronous, code-transparent, serial information transfer over a link connection. SDLC is a subset of the more generic HDLC (High-Level Data Link Control) protocol developed by the International Organization for Standardization (ISO).

**seeding:** A method for ensuring that two or more routers agree about which physical networks correspond to which network numbers and zone names. There are three options: non-seeding, soft seeding, and hard seeding. Seeding can often be set separately for each router port. See also *hard seeding*, *non-seeding*, *seed router*, and *soft seeding*.

**seed router:** A router that provides network number and zone information to any router that starts up on the same network. See also *hard seeding*, *non-seeding*, *seeding*, and *soft seeding*.

**serial port:** A connector on the back of the workstation through which data flows to and from a serial device.

**server:** A device or system that has been specifically configured to provide a service, usually to a group of clients.

**SNMP (Simple Network Management Protocol):** A protocol used for communication between management consoles and network devices. The Netopia ISDN Router can be managed through SNMP.

**soft seeding:** A router setting. In soft seeding, if a router that has just been reset detects a network number or zone name conflict between its configured information for a particular port and the information provided by another router connected to that port, it updates its configuration using the information provided by the other router. See also *hard seeding*, *non-seeding*, *seeding*, and *seed router*.

**subnet:** A network address created by using a subnet mask to specify that a number of bits in an internet address will be used as a subnet number rather than a host address.

**subnet mask:** A 32-bit number to specify which part of an internet address is the network number, and which part is the host address. When written in binary notation, each bit written as 1 corresponds to 1 bit of network address information. One subnet mask applies to all IP devices on an individual IP network.

**TCP/IP (Transmission Control Protocol/Internet Protocol):** An open network standard that defines how devices from different manufacturers communicate with each other over one or more interconnected networks. TCP/IP protocols are the foundation of the Internet, a worldwide network of networks connecting businesses, governments, researchers, and educators.

**telephone wall cable:** 2-pair, 4-pair, or 8-pair, 22- or 24-gauge solid copper wire cable. Telephone wall cable is sometimes called telephone station cable or twisted-pair cable.



**TFTP (Trivial File Transfer Protocol):** A protocol used to transfer files between IP nodes. TFTP is often used to transfer firmware and configuration information from a UNIX computer acting as a TFTP server to an IP networking device, such as the Netopia ISDN Router.

**thicknet:** Industry jargon for 10Base5 coaxial cable, the original Ethernet cabling.

**thinnet:** Industry jargon for 10Base2 coaxial cable, which is thinner (smaller in diameter) than the original Ethernet cabling.

**UDP (User Datagram Protocol):** A TCP/IP protocol describing how packets reach applications in destination nodes.

**wall jack:** A small hardware component used to tap into telephone wall cable. An RJ-11 wall jack usually has four pins; an RJ-45 wall jack usually has eight pins.

**WAN (wide area network):** A network that consists of nodes connected by long-distance transmission media, such as telephone lines. WANs can span a state, a country, or even the world.

**WAN IP:** In addition to being a router, the Netopia ISDN Router is also an IP address server. There are four protocols it can use to distribute IP addresses over the WAN which include: DHCP, BootP, IPCP, and MacIP. WAN IP is a feature for both the Small Office and Corporate Netopia ISDN Router models.

**wiring closet:** A central location where a building's telephone and network wiring is connected. Multi-story buildings often have a main wiring closet in the basement and satellite wiring closets on each floor.

**zone:** An arbitrary subset of nodes within an AppleTalk internet. Creating multiple zones makes it easier for users to locate network services. The network administrator defines zones when he or she configures routers. Isolated networks have no zones. LocalTalk and EtherTalk Phase I networks may have no more than one zone each. EtherTalk Phase II and TokenTalk networks may have more than one zone each. Several networks of any AppleTalk type may share a zone name.



# Index

## Numerics

- 10Base-T 4-4
- 10Base-T, connecting 4-4

## A

- add static route 10-19
- advanced configuration
  - features 8-11
- AppleTalk 1-1
  - configuring LocalTalk 12-7
  - routing table 13-9
  - setup 12-1
  - tunneling (AURP) 12-3, 12-8
  - zones 12-6, 12-7
- AppleTalk Update-Based Routing Protocol, *see* AURP
- application software 4-2
- AURP
  - adding a partner 12-9
  - configuration 12-10
  - connecting to a partner 12-9
  - hop-count reduction 12-12
  - network number remapping 12-11
  - receiving connections 12-10
  - setup 12-3, 12-8
  - tunnel 14-20

## B

- back panel 3-2
  - ports 3-3
- backup, line 9-1
- basic firewall 14-18

- BootP 10-21
  - clients 10-27
- broadcasts B-13

## C

- capabilities 1-1
- change static route 10-20
- community strings 13-13
- configuration
  - troubleshooting
    - PC A-1
- configuration files
  - downloading with TFTP 15-8
  - downloading with XMODEM 15-11
  - uploading with TFTP 15-9
  - uploading with XMODEM 15-11
- configuration screens
  - protecting 14-2
- configuring
  - with console-based management 6-1, 7-1, 8-1
- configuring terminal emulation software 6-3
- configuring the console 8-13
- connecting to an Ethernet network 4-3
- connecting to the configuration screens 8-9
- connection profiles
  - defined 7-5
- console
  - configuring 8-13
  - connection problems A-2
  - screens, connecting to 8-9

- console configuration 8-13
- console-based management
  - configuring with 6-1, 7-1, 8-1

## **D**

- D. port 14-9
- date and time
  - setting 8-12
- deciding on an ISP account 2-2
- default profile 8-6
- default terminal emulation software settings 6-4
- delete static route 10-20
- designing a new filter set 14-11
- DHCP
  - defined B-8
- DHCP NetBIOS options 10-26
- display static routes 10-18
- distributing IP addresses B-5
- downloading configuration files 15-8, 15-11
  - with TFTP 15-8
  - with XMODEM 15-11
- DSL G-1
- Dynamic Host Configuration Protocol (DHCP) 10-21
- Dynamic Host Configuration Protocol, *see* DHCP
- Dynamic WAN 10-21

## **E**

- Easy Setup
  - connection profile 7-5
  - IP setup 7-6
  - IPX setup 7-6
  - navigating 6-4
  - overview 7-1
  - quick connection path 7-3
- Ethernet 4-2
- EtherTalk 4-2
- event history
  - device 13-7

- WAN 13-6
- exported services 10-12

## **F**

- features 1-1
- filter
  - parts 14-7
  - parts of 14-7
- filter priority 14-5
- filter set
  - adding 14-13
  - display 14-9
- filter sets
  - adding 14-13
  - defined 14-4
  - deleting 14-17
  - disadvantages 14-11
  - modifying 14-17
  - sample (Basic Firewall) 14-17
  - using 14-12
  - viewing 14-16
- filtering example #1 14-10
- filters
  - actions a filter can take 14-6
  - adding to a filter set 14-14
  - defined 14-4
  - deleting 14-16
  - disadvantages of 14-11
  - input 14-14
  - modifying 14-16
  - output 14-14
  - using 14-12
  - viewing 14-16
- firewall 14-17
- firmware files
  - updating with TFTP 15-7
  - updating with XMODEM 15-10
- FTP sessions 14-20
- further reading E-1

**G**

general statistics 13-4  
Glossary GL-1

**H**

hard seeding 12-3  
hops 13-9  
how to reach us A-4

**I**

input filter 3 14-18  
input filters 1 and 2 14-18  
input filters 4 and 5 14-18  
Internet addresses, *see IP addresses*  
Internet Protocol (IP) 10-1  
Internetwork Packet Exchange (IPX) 11-1  
IP address serving 10-21  
IP addresses B-1  
    about B-1  
    distributing B-5  
    distribution rules B-10  
    static B-8  
IP setup 10-11  
IP trap receivers  
    deleting 13-15  
    modifying 13-15  
    setting 13-15  
    viewing 13-15  
IPX packet filter sets 14-23  
IPX packet filters 14-22  
IPX SAP Bindery Table 11-5  
IPX SAP filters 14-25  
IPX setup 11-1  
IPX spoofing 11-3  
ISP  
    account types 2-2  
    information to obtain 2-3

**L**

LED status 13-3  
LEDs 3-4, 13-3  
line backup 9-1  
    backup IP gateway 9-4  
    connection profiles 9-5  
    management and statistics 9-7  
    scheduled connections 9-5  
    WAN configuration 9-2  
LocalTalk 12-7  
    connecting 4-6  
    setup 12-7

**M**

MacIP 10-21  
    defined B-8  
MacIP (KIP Forwarding) options 10-28  
MacIP setup 12-3  
MacIP/KIP clients 10-28  
MacIP/KIP static options 10-28  
MIBs supported 13-12  
multiple subnets 10-15

**N**

NAT  
    defined 10-1  
    features 10-2  
    guidelines 10-10  
    using 10-3  
navigating  
    Easy Setup 6-4  
navigating through the configuration screens 8-10  
NCSA Telnet 6-3  
nested IP subnets B-11  
NetBIOS 10-26, 11-3  
NetBIOS scope 10-27  
Netopia  
    connecting to Ethernet, rules 4-3  
    connecting to LocalTalk 4-6  
    connection profile 7-5  
    distributing IP addresses 10-21, B-5

- IP setup 7-6
- IPX setup 7-6
- LocalTalk configuration 12-7
- monitoring 13-1
- security 14-1
- system utilities and diagnostics 15-1

Network Address Translation  
  see NAT 10-1

network problems A-2

network status overview 13-1

next router address 13-10

non-seeding 12-3

**O**

- output filter 1 14-18
- overview 1-1

**P**

- packet
  - header B-13
- packet filter
  - deleting 14-23
- packet filters
  - viewing and modifying 14-23
- packets forwarded 13-10
- password
  - to protect security screen 14-2
  - user accounts 14-1
- ping 15-2
- ping test, configuring and initiating 15-2
- port number
  - comparisons 14-8
- port numbers 14-7
- proxy addresses 10-1

**Q**

- Quick View 13-1

**R**

- restarting the system 15-12
- restricting telnet access 14-4
- RIP 10-12
- router to serve IP addresses to hosts 10-1
- Routing Information Protocol (RIP) 11-2
- routing tables
  - AppleTalk 13-9
  - IP 10-17, 13-8

**S**

- SAP filter sets
  - viewing and modifying 14-28
- SAP server types 11-3
- screens, connecting to 8-9
- SDSL
  - defined G-1
- security
  - filters 14-4–14-20
  - measures to increase 14-1
  - telnet 14-4
  - user accounts (passwords) 14-1
- security options screen 14-2
- protecting 14-2
- seeding 12-3
- Service Advertising Protocol (SAP) 11-2
- Simple Network Management Protocol, *see*  
  SNMP
- SmartIP 10-1
- SmartStart
  - before launching 5-2
  - requirements
    - Macintosh 5-2
    - PC 5-2
    - Windows 95 5-3
- SNMP
  - community strings 13-13
  - MIBs supported 13-12
  - setup screen 13-13
  - traps 13-14

- socket 11-2
- soft seeding 12-3
- src. port
  - 14-9
- state 13-10
- static IP addresses B-8
- static route
  - rules of installation 10-20
- static routes 10-12, 10-17
- statistics, WAN 13-4
- subnet masks B-3
- subnets B-2–B-5
  - multiple 10-15
  - nested B-11
- subnets and subnet masks B-2
- support
  - technical A-4

**T**

- TCP/IP stack 4-2
- technical support A-4
- telnet 6-2
  - access 8-9, 14-4
- terminal emulation software
  - configuring 6-3
  - default settings 6-4
- TFTP
  - defined 15-7
  - downloading configuration files 15-8
  - updating firmware 15-7
  - uploading configuration files 15-9
- TFTP, transferring files 15-7
- Trivial File Transfer Protocol (TFTP) 15-7
- Trivial File Transfer Protocol, *see* TFTP
- troubleshooting A-1
  - configuration
    - PC A-1
  - console-based management 7-2
  - event histories 13-5, 13-17
  - WAN statistics 13-4

- trusted host 14-19
- trusted subnet 14-19
- tunneling 12-3

**U**

- unproxied addresses 10-1
- updating firmware
  - with TFTP 15-7
  - with XMODEM 15-10
- updating Netopia's firmware 15-7
- uploading configuration files 15-9
  - with TFTP 15-9
  - with XMODEM 15-11
- user accounts 14-1
- utilities and diagnostics 15-1

**W**

- WAN
  - configuration 10-3
  - event history 13-6
  - statistics 13-4
- WAN event history 13-6
- web-based management
  - system information 13-16
- Windows 95
  - SmartStart 5-3

**X**

- XMODEM 15-9
- XMODEM file transfers
  - downloading configuration files 15-11
  - updating firmware 15-10
  - uploading configuration files 15-11

**Z**

- zone name 13-9





# *Limited Warranty and Limitation of Remedies*

Netopia warrants to you, the end user, that the Netopia R7200 SDSL Router (the "Product") will be free from defects in materials and workmanship under normal use for a period of one (1) year from date of purchase. Netopia's entire liability and your sole remedy under this warranty during the warranty period is that Netopia shall, at its sole option, either repair or replace the Product.

In order to make a claim under this warranty you must comply with the following procedure:

1. Contact Netopia Customer Service within the warranty period to obtain a Return Materials Authorization ("RMA") number.
2. Return the defective Product and proof of purchase, shipping prepaid, to Netopia with the RMA number prominently displayed on the outside of the package.

If you are located outside of the United States or Canada, please contact your dealer in order to arrange for warranty service.

THE ABOVE WARRANTIES ARE MADE BY NETOPIA ALONE, AND THEY ARE THE ONLY WARRANTIES MADE BY ANYONE REGARDING THE ENCLOSED PRODUCT. NETOPIA AND ITS LICENSOR(S) MAKE NO OTHER WARRANTIES, EXPRESS OR IMPLIED, INCLUDING WITHOUT LIMITATION THE IMPLIED WARRANTIES OF MERCHANTABILITY AND FITNESS FOR A PARTICULAR PURPOSE, REGARDING THE ENCLOSED PRODUCT. EXCEPT AS OTHERWISE EXPRESSLY PROVIDED ABOVE, NETOPIA AND ITS LICENSOR(S) DO NOT WARRANT, GUARANTEE OR MAKE ANY REPRESENTATION REGARDING THE USE OR THE RESULTS OF THE USE OF THE PRODUCT IN TERMS OF ITS CORRECTNESS, ACCURACY, RELIABILITY, CURRENTNESS, OR OTHERWISE. THE ENTIRE RISK AS TO THE RESULTS AND PERFORMANCE OF THE PRODUCT IS ASSUMED BY YOU. THE EXCLUSION OF IMPLIED WARRANTIES IS NOT PERMITTED BY SOME STATES OR JURISDICTIONS, SO THE ABOVE EXCLUSION MAY NOT APPLY TO YOU. IN THAT CASE, ANY IMPLIED WARRANTIES ARE LIMITED IN DURATION TO NINETY (90) DAYS FROM THE DATE OF DELIVERY OF THE PRODUCT. THERE MAY BE OTHER RIGHTS THAT YOU MAY HAVE WHICH VARY FROM JURISDICTION TO JURISDICTION.

REGARDLESS OF WHETHER OR NOT ANY REMEDY SET FORTH HEREIN FAILS OF ITS ESSENTIAL PURPOSE, IN NO EVENT WILL NETOPIA, ITS LICENSOR(S) AND THE DIRECTORS, OFFICERS, EMPLOYEES OR AGENTS OF ANY OF THEM BE LIABLE TO YOU FOR ANY CONSEQUENTIAL, INCIDENTAL OR INDIRECT DAMAGES (INCLUDING DAMAGES FOR LOSS OF BUSINESS PROFITS, BUSINESS INTERRUPTION, LOSS OF BUSINESS INFORMATION, AND THE LIKE) ARISING OUT THE USE OR INABILITY TO USE THE PRODUCT EVEN IF NETOPIA OR ITS LICENSOR(S) HAVE BEEN ADVISED OF THE POSSIBILITY OF SUCH DAMAGES. BECAUSE SOME STATES OR JURISDICTIONS DO NOT ALLOW THE EXCLUSION OR LIMITATION OF LIABILITY FOR CONSEQUENTIAL OR INCIDENTAL DAMAGES, THE ABOVE LIMITATIONS MAY NOT APPLY TO YOU. NETOPIA AND ITS LICENSOR(S) LIABILITY TO YOU FOR ACTUAL DAMAGES FROM ANY CAUSE WHATSOEVER, AND REGARDLESS OF THE FORM OF THE ACTION (WHETHER IN CONTRACT, TORT [INCLUDING NEGLIGENCE], PRODUCT LIABILITY OR OTHERWISE), WILL BE LIMITED TO \$50. v.300

